

NAME OF LEARNER:
NAAM VAN LEERDER:

CLASS:
KLAS:

**NATIONAL SENIOR CERTIFICATE
*NASIONALE SENIOR SERTIFIKAAT***

MATHEMATICS P2/*WISKUNDE V2*

GRADE/*GRAAD* 11

NOVEMBER 2015

**SPECIAL ANSWER BOOK
*SPESIALE ANTWOORDEBOEK***

QUESTION <i>VRAAG</i>	MARK <i>PUNT</i>			INITIAL <i>PARAAF</i>	MODERATION <i>MODERERING</i>			INITIAL <i>PARAAF</i>
1								
2								
3								
4								
5								
6								
7								
8								
9								
10								
11								
TOTAL <i>TOTAAL</i> (150)								

**This answer book consists of 24 pages.
*Hierdie antwoordeboek bestaan uit 24 bladsye.***

QUESTION/VRAAG 1

56	68	69	71	71	72	82	84	85
88	89	90	92	93	94	96	97	99
102	103	127	128	134	135	137	144	156

	Solution/Oplissing	Marks Punte
1.1		(2)
1.2		(1)
1.3		(1)
1.4		(3)
1.5		(2)

1.6		(2)
1.7		(3)
		[14]

QUESTION/VRAAG 2

WEIGHT LOSS OVER 4 WEEKS (IN GRAMS)/ GEWIGSVERLIES IN 4 WEKE (IN GRAM)	FREQUENCY/ FREKWENSIE
$1\ 000 < x \leq 1\ 500$	2
$1\ 500 < x \leq 2\ 000$	3
$2\ 000 < x \leq 2\ 500$	3
$2\ 500 < x \leq 3\ 000$	4
$3\ 000 < x \leq 3\ 500$	5
$3\ 500 < x \leq 4\ 000$	7
$4\ 000 < x \leq 4\ 500$	2
$4\ 500 < x \leq 5\ 000$	1

	Solution/Oplissing	Marks Punte
2.1		
		(2)

2.2

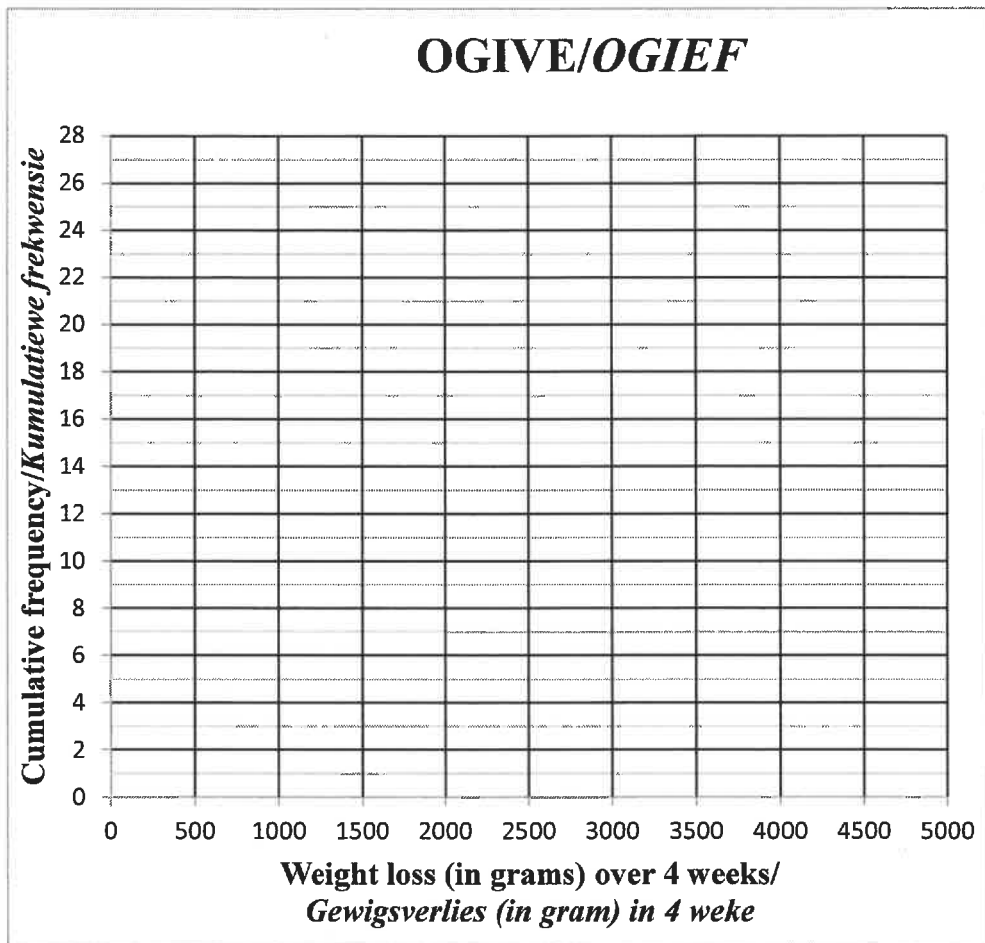

(4)

2.3

(2)

[8]

QUESTION/VRAAG 3

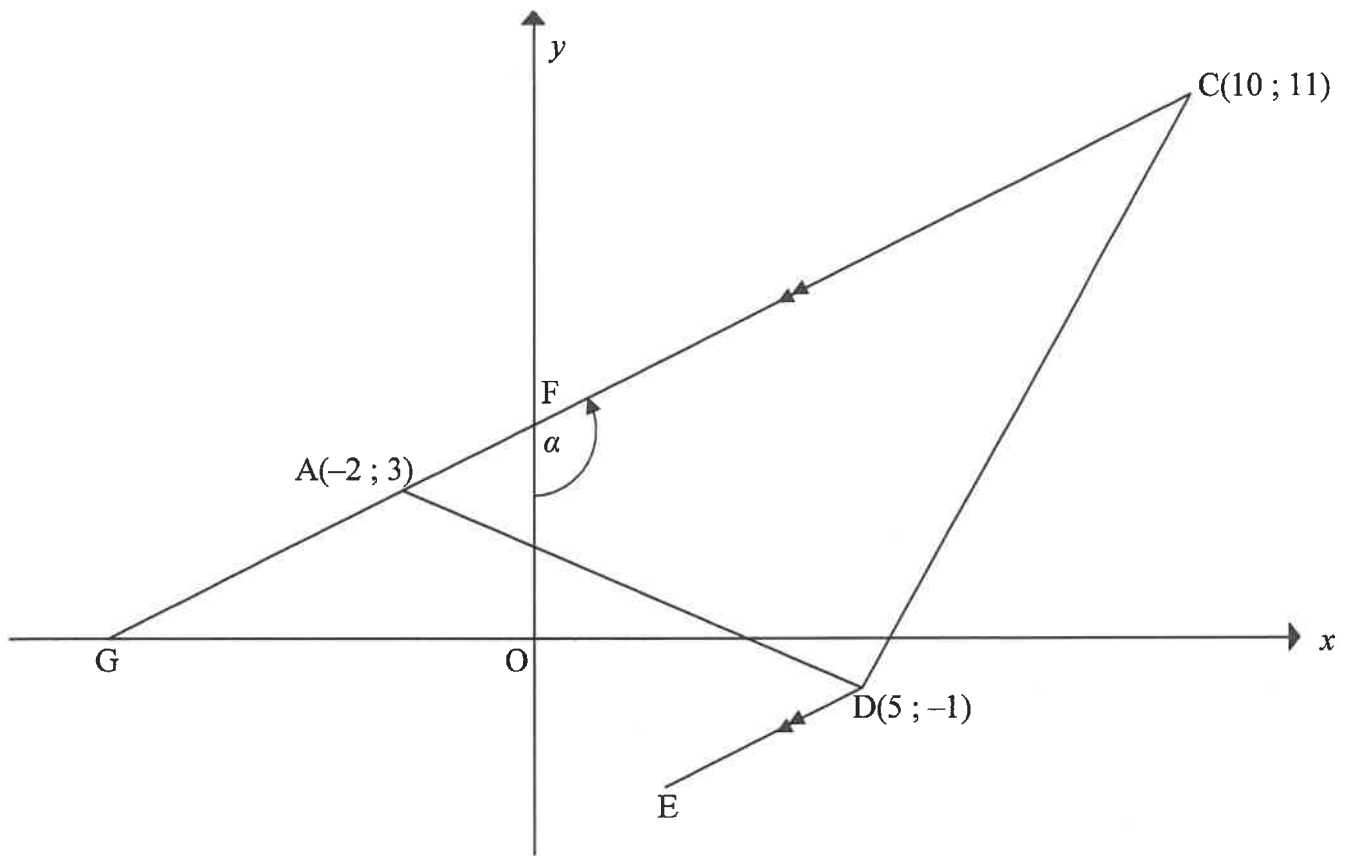

	Solution/Oplissing	Marks Punte
3.1		
		(2)
3.2		
		(3)

	Solution/Oplissing	Marks Punte
3.3		
3.4.1		
3.4.2		
		[14]

QUESTION/VRAAG 4

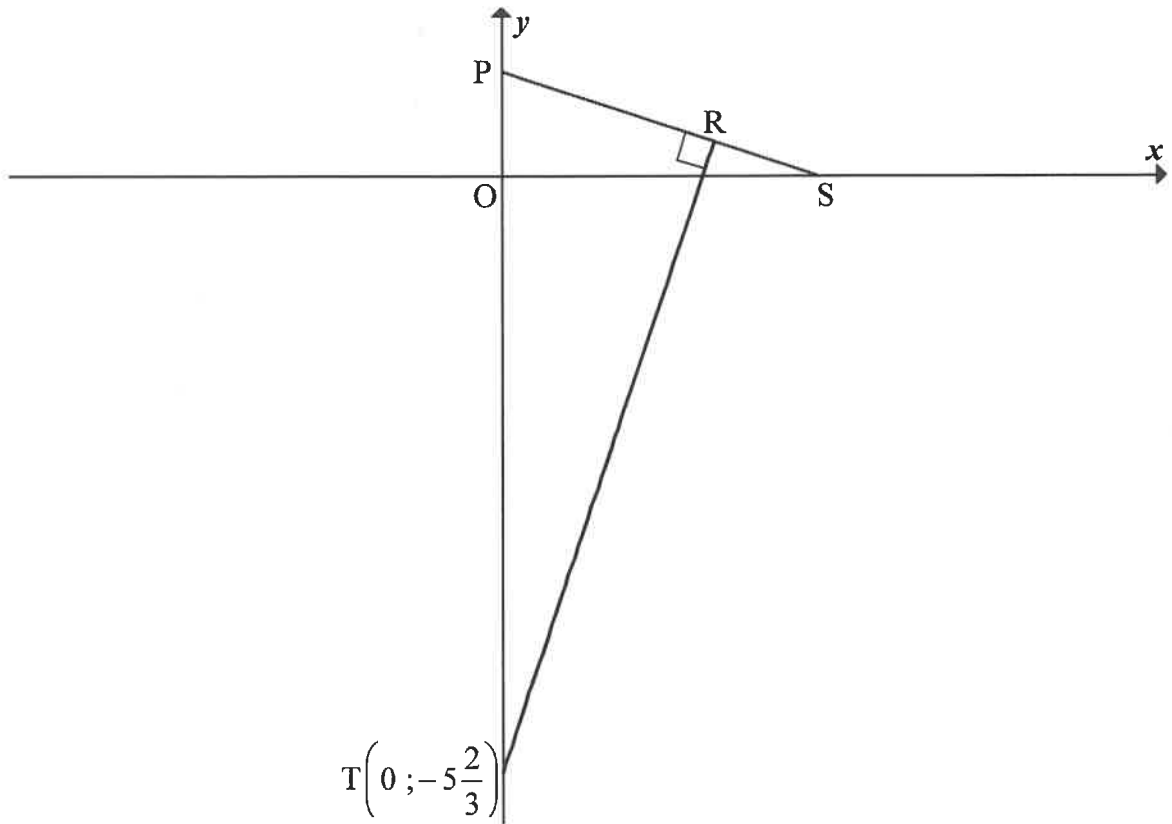

	Solution/Oplissing	Marks Punte
4.1		(2)
4.2		(2)

	Solution/Oplissing	Marks Punte
4.3		
		(3)
4.4		
		(4)
4.5		
		(3)
4.6		
		(2)
		[16]

QUESTION/VRAAG 5

5.1

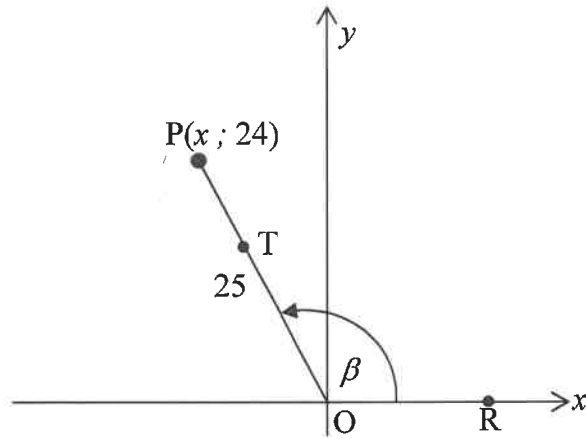

	Solution/Oplissing	Marks Punte
5.1.1		
		(2)
5.1.2(a)		
		(1)
5.1.2(b)		
		(2)
5.1.2(c)		
		(2)

	Solution/Oplissing	Marks Punte
5.1.3		
		(4)
5.2		
		(4)
5.3.1		
		(3)

	Solution/Oplissing	Marks Punte
5.3.2		
		(6) [24]

	Additional space/Bykomende ruimte	Marks Punte

QUESTION/VRAAG 6

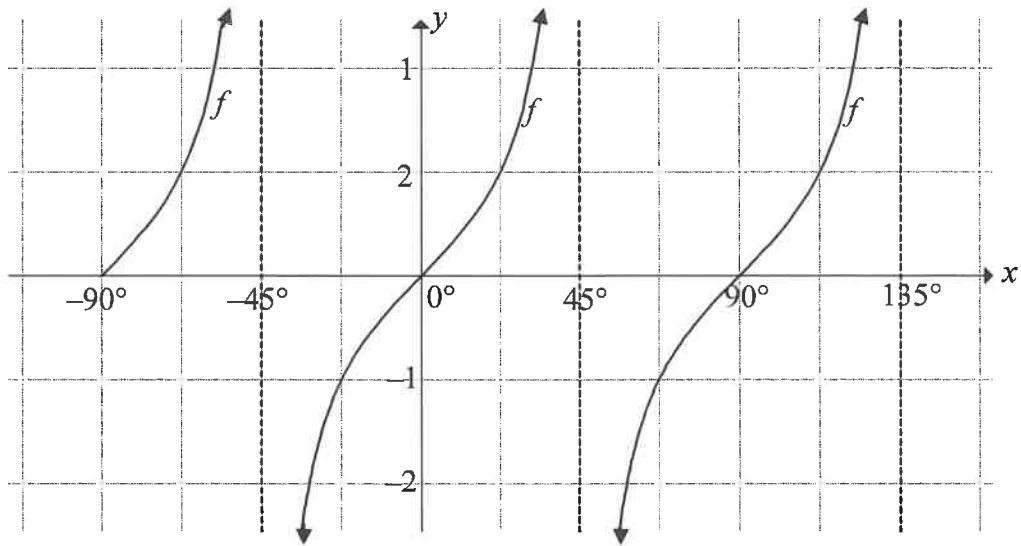

	Solution/Oplissing	Marks Punte
6.1.1		(1)
6.1.2		(2)
6.1.3		(2)

	Solution/Oplissing	Marks Punte
6.2.1		(4)
6.2.2	<div style="border-bottom: 1px dotted black; height: 15px; margin-bottom: 5px;"></div> <div style="border-bottom: 1px dotted black; height: 15px; margin-bottom: 5px;"></div> <div style="border-bottom: 1px dotted black; height: 15px; margin-bottom: 5px;"></div> <div style="border-bottom: 1px dotted black; height: 15px; margin-bottom: 5px;"></div>	(2)
6.2.3	<div style="border-bottom: 1px solid black; height: 15px; margin-bottom: 5px;"></div> <div style="border-bottom: 1px solid black; height: 15px; margin-bottom: 5px;"></div> <div style="border-bottom: 1px solid black; height: 15px; margin-bottom: 5px;"></div> <div style="border-bottom: 1px solid black; height: 15px; margin-bottom: 5px;"></div> <div style="border-bottom: 1px solid black; height: 15px; margin-bottom: 5px;"></div> <div style="border-bottom: 1px solid black; height: 15px; margin-bottom: 5px;"></div> <div style="border-bottom: 1px solid black; height: 15px; margin-bottom: 5px;"></div> <div style="border-bottom: 1px solid black; height: 15px; margin-bottom: 5px;"></div> <div style="border-bottom: 1px solid black; height: 15px; margin-bottom: 5px;"></div> <div style="border-bottom: 1px solid black; height: 15px; margin-bottom: 5px;"></div> <div style="border-bottom: 1px solid black; height: 15px; margin-bottom: 5px;"></div> <div style="border-bottom: 1px solid black; height: 15px; margin-bottom: 5px;"></div>	(6)

	Solution/Oplissing	Marks Punte
6.2.4		(2)
6.2.5		(2)
		[21]

	Additional space/Bykomende ruimte	Marks Punte

QUESTION/VRAAG 7

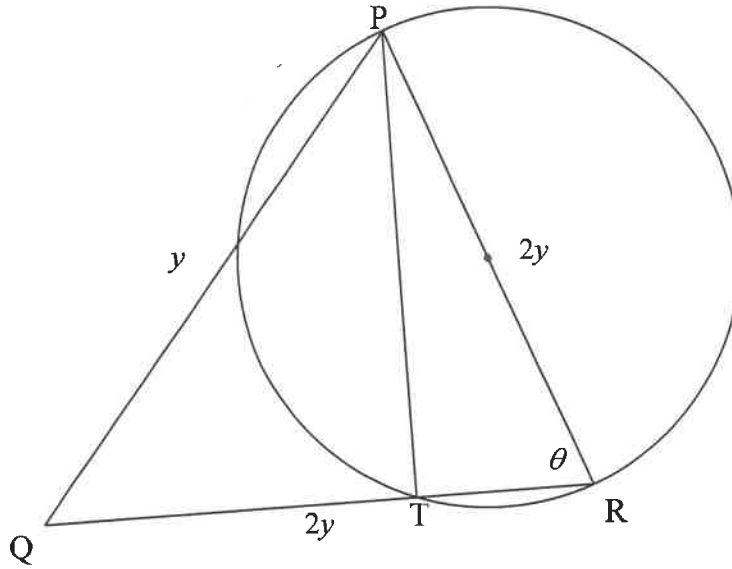

	Solution/Oplissing	Marks Punte
7.1		(4)
7.2		(3)
		[7]

QUESTION/VRAAG 8

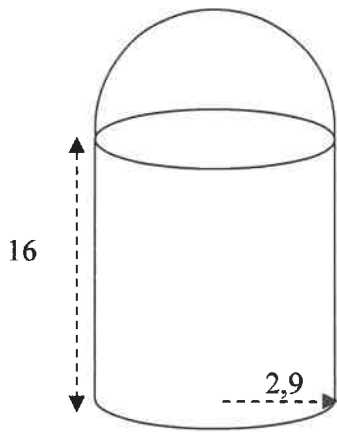

FIGURE 1

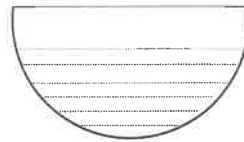
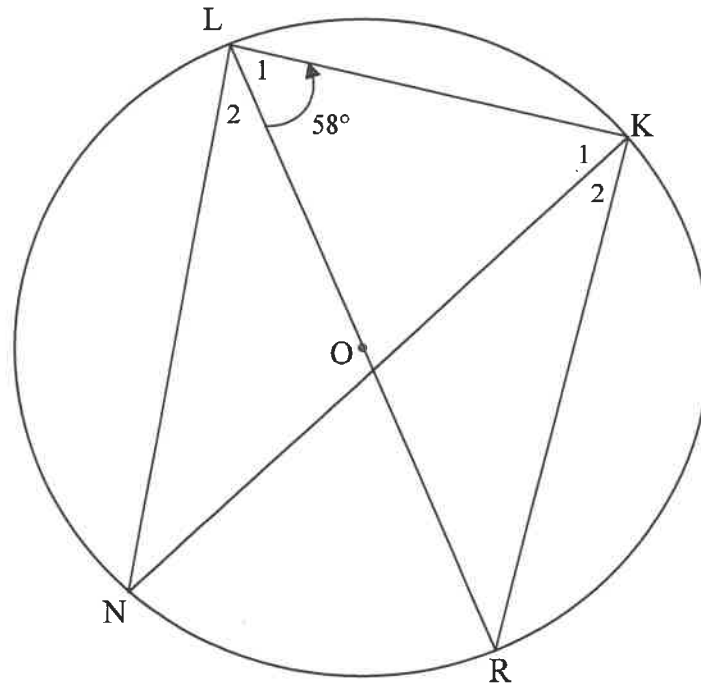

FIGURE 2

	Solution/Oplissing	Marks Punte
8.1		
		(5)
8.2		
		(3)
		[8]

Give reasons for your statements and calculations in QUESTIONS 9, 10 and 11.
 Gee redes vir jou bewerings en berekeninge in VRAAG 9, 10 en 11.

QUESTION/VRAAG 9



	Solution/Oplissing	Marks Punte
9.1		(2)
9.2		(2)
9.3		(2)
		[6]

QUESTION/VRAAG 10

10.1

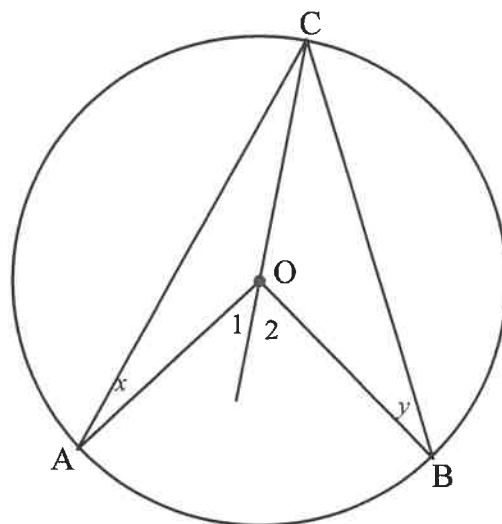

	Solution/Oplissing	Marks Punte
10.1.1		(3)
10.1.2		(3)

10.2

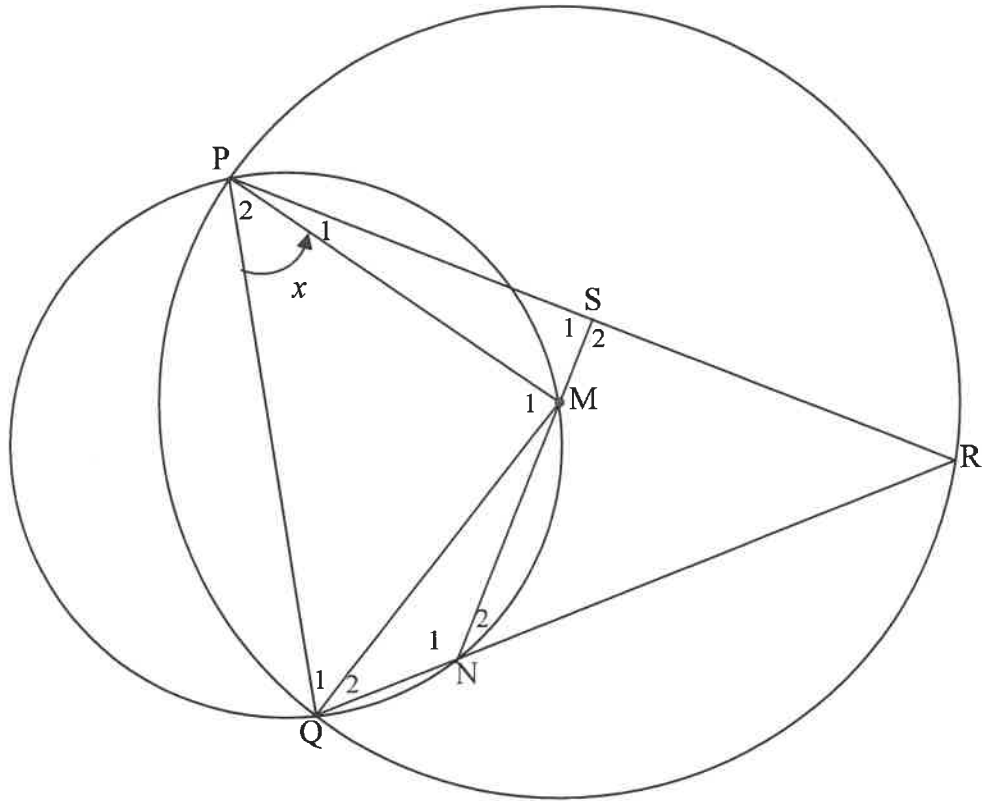

	Solution/Oplissing	Marks Punte
10.2.1		(1)
10.2.2		(2)
10.2.3		(3)
10.2.4		(3)
		[15]

QUESTION/VRAAG 11

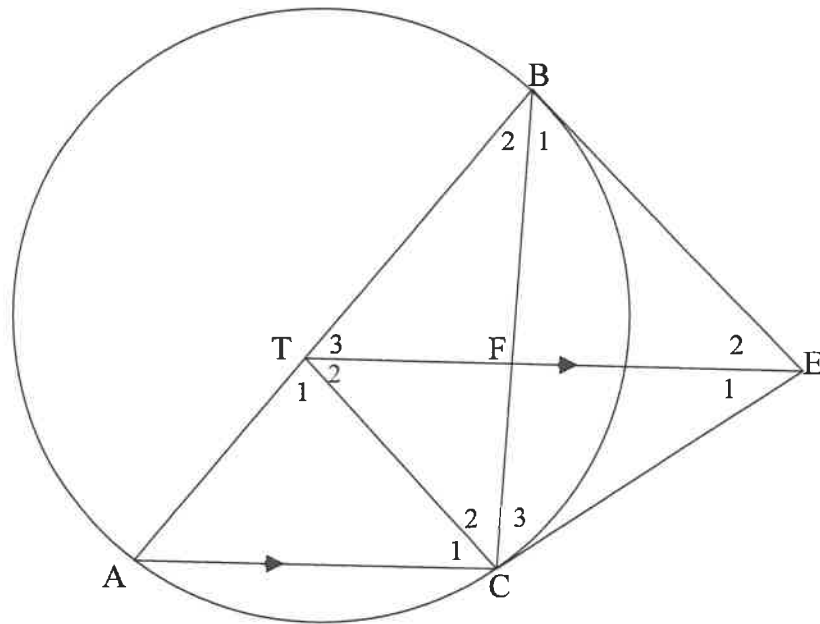

	Solution/Oplissing	Marks Punte
11.1		(4)
11.2		(4)

11.3		(2)
11.4		(4)
11.5		(3)
		[17]

	Additional space/Bykomende ruimte	Marks Punte

TOTAL/TOTAAL: 150