



basic education

Department:
Basic Education
REPUBLIC OF SOUTH AFRICA

NASIONALE SENIOR SERTIFIKAAT

GRAAD 12

INGENIEURSGRAFIKA EN -ONTWERP V2

FEBRUARIE/MAART 2014

MEMORANDUM

PUNTE: 100

Hierdie memorandum bestaan uit 5 bladsye.

ANTWOORDE		
1	18000	1
2	ALUMINIUM	1
3	562 CB - SS.dwg	1
4	2013/10/12	1
5	GAUTENG	1
6	SENERLYN / HARTLYN	1
7	RONDING	1
8	32 mm	1
9	RIB	1
10	2,5 mm	1
11	70	1
12	60°	1
13	VOLSNIT	1
14	16	1
15	STEEK-SIRKEL-DIAMETER	1
16	6	1
17	SIRKEL PATROON (C)	2
18	<i>(Sien hieronder.)</i>	3
19	A. Ø76 B. 64 SSD C. M14 D. 10 E. 16	5
20	<i>(Sien hieronder.)</i>	4
TOTAAL		30

18

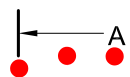

(● X 2) = 3

20

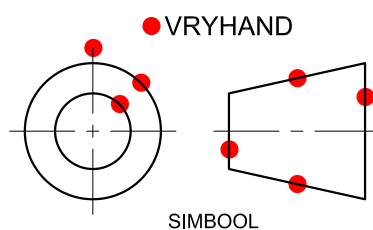

VRAESTEL 2 VRAAG 1
 GRAAD 12
 FEB. - MRT. 2014
 MEMORANDUM

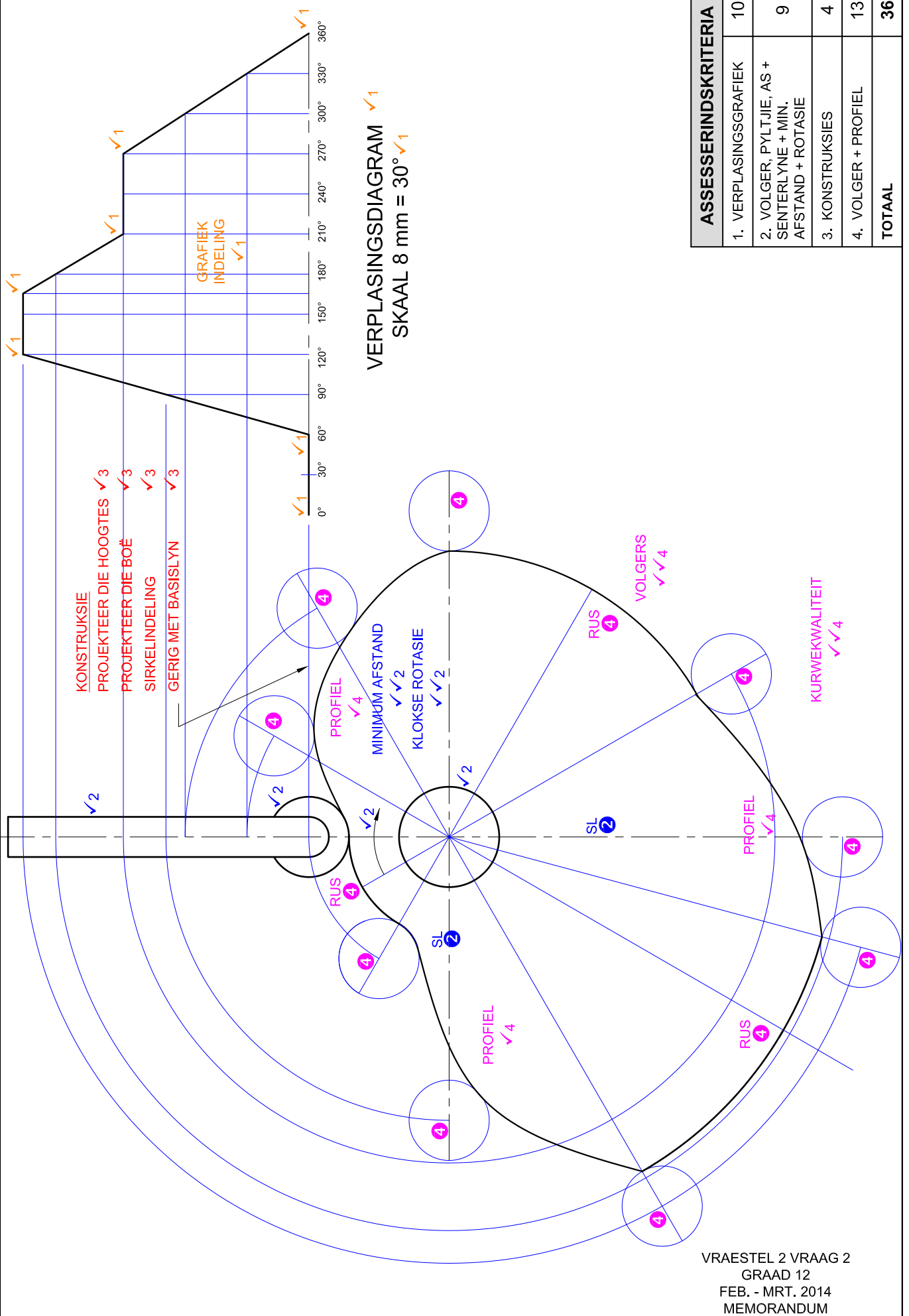

ASSESSERINGSKRITERIA	
1. VERPLASINGSGRAFIEK	10
2. VOLGER, PYLTJIE, AS + SENTERLYNE + MIN. AFSTAND + ROTASIE	9
3. KONSTRUKSIES	4
4. VOLGER + PROFIEL	13
TOTAAL	36

VRAESTEL 2 VRAAG 2
 GRAAD 12
 FEB. - MRT. 2014
 MEMORANDUM

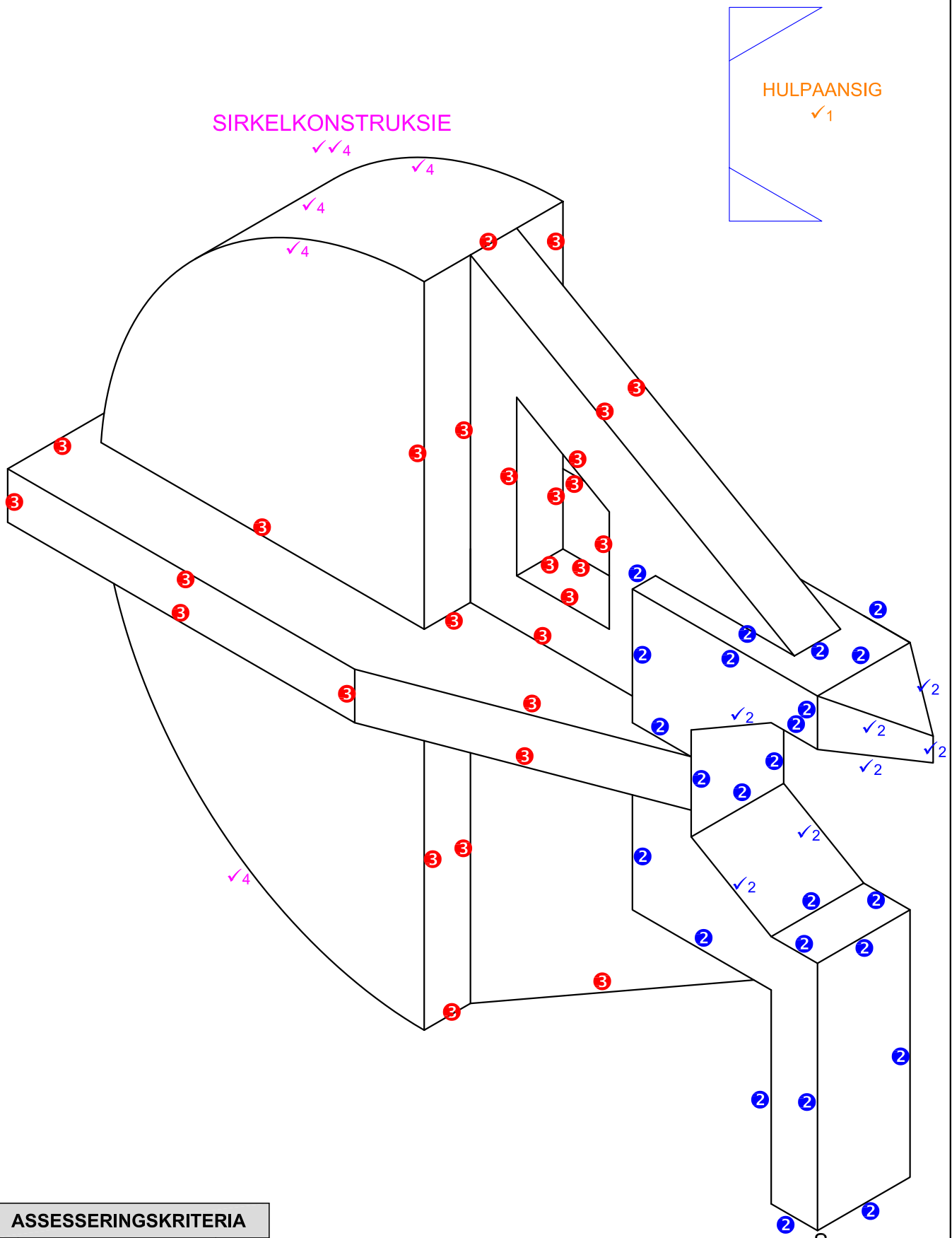

HULPAANSIG
✓1

SIRKELKONSTRUKSIE

✓✓4

✓4

✓4

✓4

S
PLASING
✓1

ASSESSERINGSKRITERIA		
1	HULPAANSIG + PLASING	2
2	VOOR	19
3	MIDDEL	14
4	KONSTR. + SIRKEL	6
TOTAAL		41

VRAESTEL 2 VRAAG 3
GRAAD 12
FEB. - MRT. 2014
MEMORANDUM

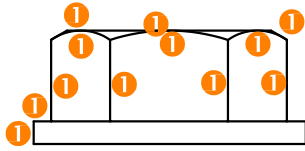

PUNTTOEKENNING VIR DIE SESKANTIGE BOUTKOP WAT DRIE VLAKKE EN DIE WASTER TOON.

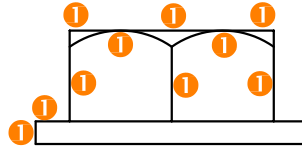

PUNTTOEKENNING VIR DIE SESKANTIGE BOUTKOP WAT TWEE VLAKKE EN DIE WASTER TOON.

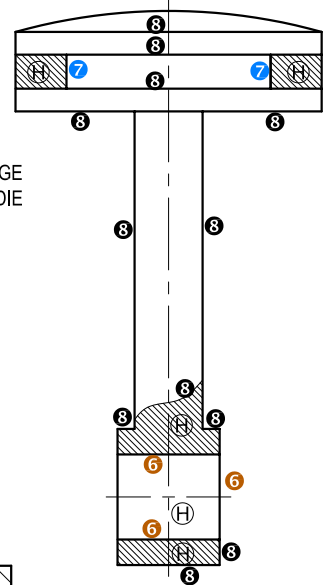
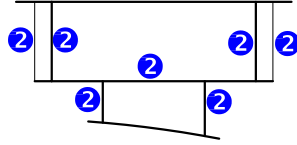

ALTERNATIEWE VOORSTELLING VAN DIE SUIER WAT DIE HERINDELING VAN PUNTE TOON (ASSESSERINGSKRITERIA 8).

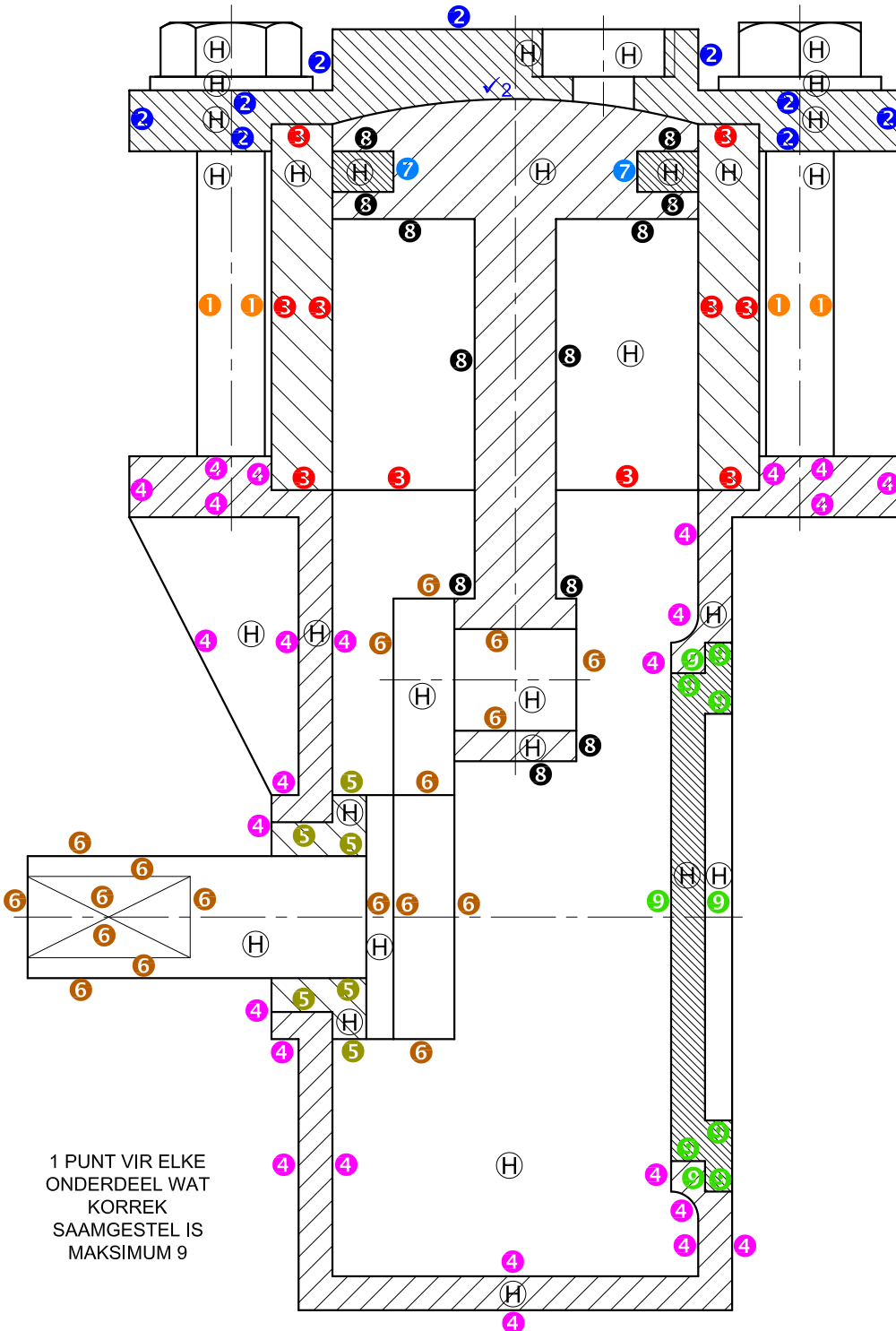

1 PUNT VIR ELKE ONDERDEEL WAT KORREK SAAMGESTEL IS MAKSIMUM 9

ASSESSERINGSKRITERIA

DEURSNEEVOORAANSIG

1	M12-BOUT + WASTER	15
2	SILINDERKOP	9
3	SILINDER	5
4	KRUKKAS	13
5	BUS	3
6	KRUKAS	9
7	SUIERRING	1
8	SUIER	6
9	KRUKKAS-DEKSEL	5
H	ARSERING	15
SUBTOTAAL		81

ALGEMEEN

1	SENERLYNE	3
2	SAMESTELLING	9
SUBTOTAAL		12
TOTAAL		93

VRAESTEL 2 VRAAG 4
 GRAAD 12
 FEB. - MRT. 2014
 MEMORANDUM