



# basic education

Department:  
Basic Education  
**REPUBLIC OF SOUTH AFRICA**

## **NATIONAL SENIOR CERTIFICATE**

**GRADE 12**

**ELECTRICAL TECHNOLOGY**

**FEBRUARY/MARCH 2012**

**MEMORANDUM**

**MARKS: 200**

**This memorandum consists of 13 pages.**

**INSTRUCTIONS TO MARKERS**

1. All questions with multiple answers imply that any relevant, acceptable answer should be considered.
2. Calculations:
  - 2.1 All calculations must show the formula(e).
  - 2.2 Substitution of values must be done correctly.
  - 2.3 All answers must contain the correct unit to be considered.
  - 2.4 Alternative methods must be considered, provided that the same answer is obtained.
  - 2.5 Where an erroneous answer could be carried over to the next step, the first answer will be deemed incorrect. However, should the incorrect answer be carried over correctly, the marker has to re-calculate the values, using the incorrect answer from the first calculation. If correctly used, the learner should receive the full marks for subsequent calculations.

**QUESTION 1: TECHNOLOGY, SOCIETY AND THE ENVIRONMENT**

- 1.1 It is not ethical because the person's life and that of fellow workers will be endangered ✓  
In relation to safety measures ✓ he and his supervisor may be held accountable and liable ✓ (3)
- 1.2 It is important to do market research for the following reasons:  
Need to find a market for the product manufactured ✓ if the product is to be a success financially it has to be sold at a profit. ✓  
The product must be cost effective to make ✓ to sell it at a competitive price so that people will purchase the product ✓ (4)
- 1.3 Hydro energy ✓  
Solar systems ✓  
Wave energy ✓  
Wind energy  
Geothermal energy  
(Any three) (3)
- [10]**

**QUESTION 2: TECHNOLOGICAL PROCESS**

- 2.1 Identify the problem and investigate means of solving it. ✓  
Design possible solutions. ✓  
Develop (make) the final product/artefact. ✓  
Evaluate the product/artefact.  
Communicate/present the process in the form of a project portfolio.  
Make or construct the artefact in accordance to the technological solution.  
(Any three) (3)
- 2.2 The artefact/project can be realised reducing problems. ✓  
The artefact/project can be achieved within timeframes. ✓  
Costing within budget allocation as planning is done. ✓  
Design in accordance to correct planning and specifications.  
Layout, design, circuit can be very neat and aesthetically pleasing.  
Functionality of project according to design process.  
Creative and innovative solutions were offered.  
Project/artefact can be utilised again. (Any three) (3)
- 2.3 Track layout is crucial to ensure that the board is electrically sound. ✓ The tracks must not touch, must be the correct width, must not peel from the board must accommodate all the components. ✓  
  
The component layout is important to ensure correct operation, ✓ good visual appearance and must handle the expected temperatures of the circuit and must be cost effective ✓ (4)
- [10]**

**QUESTION 3: OCCUPATIONAL HEALTH AND SAFETY**

- 3.1 Water is an electrical conductor. ✓ If water is used in fighting an electrical fire further fault conditions may occur which may lead to electric shock. ✓ (2)
- 3.2 The type work that will be done in an electrical technology workshop requires the correct lighting level because good visual sight ✓ is crucial in soldering work, making electrical connections ✓ and other electrical work. (2)
- 3.3 Direct contact with the following.  
Open wounds ✓  
Blood ✓  
Infected needles  
Unprotected sex (Any two) (2)
- 3.4 When using an electrical appliance that has a conducting material under faulty conditions, ✓ the user may be shocked. ✓ With the earth leakage unit any earth fault above 20 mA will immediately activate the unit, isolating the supply and rendering the appliance safe. (2)
- 3.5 Safety goggles ✓ (1)
- 3.6 To prevent accidents ✓  
Ensure correct operation (Any one relevant answer) (1)
- [10]**

**QUESTION 4: THREE-PHASE AC GENERATION**

- 4.1 A three-phase system for the same size frame:  
Is more efficient ✓  
Operates at a better power factor ✓  
Is self-starting without additional circuitry (Any two) (2)
- 4.2 To be able to supply consumers with both single-phase ✓ and three-phase power ✓ (2)
- 4.3 4.3.1  $I_{PL} = \frac{I_L}{\sqrt{3}}$  ✓  
 $I_{PL} = \frac{5}{\sqrt{3}}$  ✓  
 $I_{PL} = 2,89A$  ✓ (3)

$$4.3.2 \quad P_L = \sqrt{3} \times V_L V_L \cos \phi \quad \checkmark$$

$$P_L = \sqrt{3} \times 380 \times 5 \times 0.9 \quad \checkmark$$

$$P_L = 2,962 \text{ kW} \quad \checkmark$$

(3)  
[10]**QUESTION 5: RLC CIRCUITS**5.1 The brightness will increase.  $\checkmark$  (1)

5.2 It decreases the efficiency of both the supply system and equipment  $\checkmark$   
 It limits the output of both generators and transformers  
 It causes a greater fall in terminal voltage.  
 A higher current is drawn to deliver the same power. (Any one) (1)

5.3 5.3.1

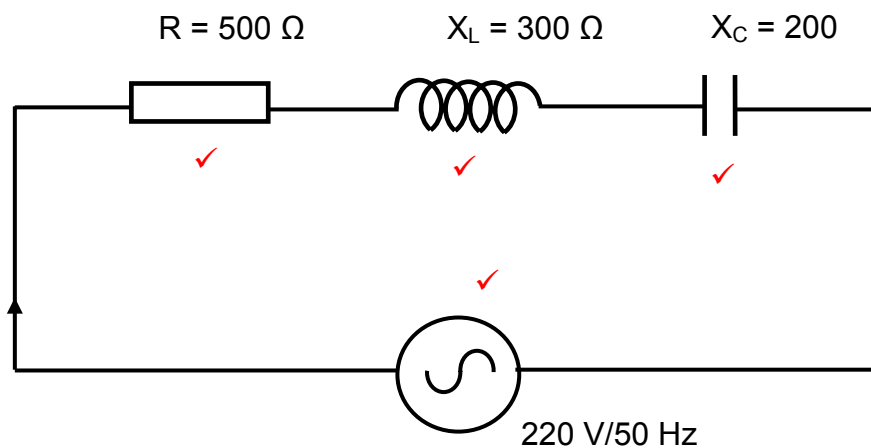

(4)

$$5.3.2 \quad Z = \sqrt{R^2 + (X_L - X_C)^2} \quad \checkmark$$

$$= \sqrt{500^2 + (300 - 200)^2} \quad \checkmark$$

$$= 509,9 \Omega \quad \checkmark$$

(3)

$$5.3.3 \quad \cos \theta = \frac{R}{Z} \quad \checkmark$$

$$= \frac{500}{509,9} \quad \checkmark$$

$$= 0,98 \text{ Lagging} \quad \checkmark$$

(4)

5.4 5.4.1  $V_S = \sqrt{V_R^2 + (V_C - V_L)^2}$  ✓  
 $= \sqrt{120^2 + (122.84 - 85)^2}$  ✓  
 $= 125.82 \text{ V}$  ✓ (3)

5.4.2  $X_L = \frac{V_L}{I_S}$  ✓  
 $= \frac{85}{1.5}$  ✓  
 $= 56.67 \Omega$  ✓ (3)

5.4.3  $X_C = \frac{V_C}{I_S}$  ✓  
 $= \frac{122.84}{1.5}$  ✓  
 $= 81.85 \Omega$  ✓ (3)

$X_C = \frac{1}{2\pi FC}$  ✓  
 $C = \frac{1}{2\pi FX_C}$  ✓  
 $= \frac{1}{2\pi \times 50 \times 81.85}$   
 $= 38.89 \mu\text{F}$  ✓ (3)

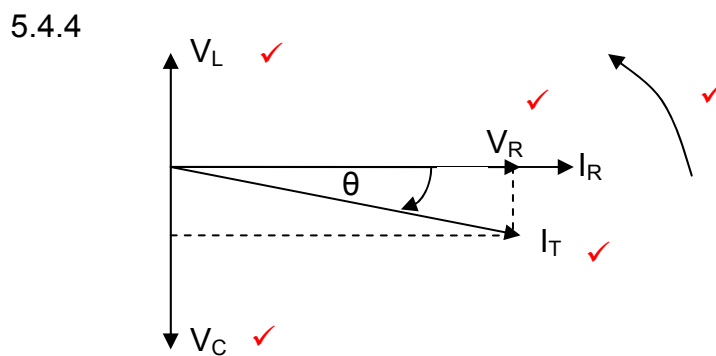

Rotation anti clockwise.  
 If the learner fails to show direction of rotation, deduct one mark. (5)  
**[30]**

**QUESTION 6: SWITCHING AND CONTROL CIRCUITS**

6.1

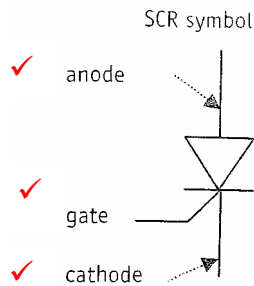

(3)

6.2 The anode must be connected to the positive ✓ and the cathode connected to the negative. ✓ A positive pulse must now be applied to the gate and the SCR will be triggered into conduction. ✓

OR

The anode must be connected to the positive and the cathode connected to the negative. If this voltage is now increased above  $V_{BO}$  of the SCR it will now conduct.

(3)

6.3 6.3.1 At reverse breakdown voltage the SCR will begin to conduct ✓ there will be a large flow of current ✓ which will lead to the destruction of the component. ✓

(3)

6.3.2 There will be a forward voltage  $V_{ak}$  of about 1 V across it. ✓  
The voltage will be very low.

(1)

6.3.3 When the SCR is conducting a current will flow through it that is determined by the load ✓ that is connected in series with the SCR. ✓

(2)

6.3.4 If the current drops below  $I_H$ , the holding current ✓ the SCR will stop conducting; it will turn off. ✓

(2)

6.4 6.4.1 1. TRIAC ✓  
2. DIAC ✓

(2)

6.4.2 By adjusting  $R_2$  the time constant is changed ✓ ( $t=RC$ ). Decreasing  $R_2$  the time constant is reduced ✓ The time it takes to charge up the capacitor (C) to the voltage ( $V_{DIAC}$ ) that will trigger the DIAC causing it to conduct ✓ will be reduced thus ✓ reducing the angle at which the TRIAC is fired resulting in the TRIAC being fired quicker ✓ increasing the brightness of the lamp. ✓

(6)

6.4.3 The function of  $R_1$  is to limit the current ✓ in the event that  $R_2$  is set to 0 ohms, i.e. a short circuit. ✓

OR

The resistor acts as a current-limiting device.

(2)

6.5 Thyristor control has far less heat loss than resistor control. ✓

(1)

**[25]**

**QUESTION 7: AMPLIFIERS**

7.1

INPUT	OUTPUT
If $V_1 > V_2$	$V_{OUT} = \text{negative } (-V_{CC})$ ✓
If $V_1 < V_2$	$V_{OUT} = \text{positive } (+V_{CC})$ ✓
If $V_1 = V_2$	$V_{OUT} = 0\text{ V}$ ✓

(3)

7.2

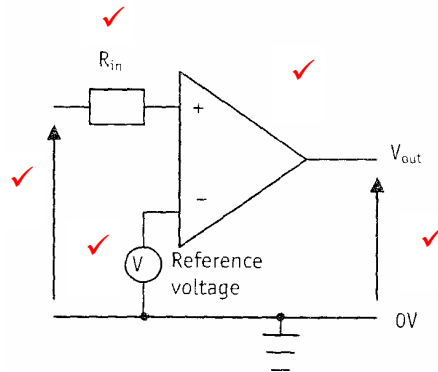

**NON-INVERTING VOLTAGE COMPARATOR**

(5)

7.3

It is a set of rules ✓ in terms of which the output reacts ✓ when a signal is applied to either of the inputs. ✓  
The op-amp amplifies the difference between the input signals. It operates as a differential amplifier.

(3)

7.4

7.4.1 Inverting op-amp ✓

(1)

7.4.2

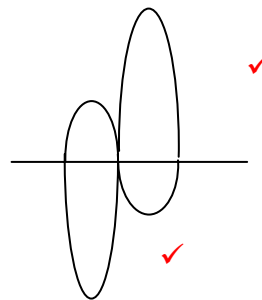

(2)

7.4.3 Voltage across  $R_f$  will increase ✓ this will decrease the feedback ✓ to the non-inverting input ✓

(3)

7.4.4  $R_{IN}$  connect the input ✓ signal to the non inverting ✓ input of the op-amp and together with  $R_f$  determine the gain of the op-amp

(2)

7.4.5 The 0 V rail ✓

(1)

7.5

A voltage amplifier ✓

(1)



- 7.6      7.6.1    Stable ✓ under most practical ✓ conditions (2)
- 7.6.2    Two inputs, inverting ✓ and non inverting inputs ✓ (2)
- [25]**

### QUESTION 8: THREE-PHASE TRANSFORMERS

- 8.1      Copper losses ✓  
            Iron losses  
            Stray losses  
            Dielectric losses (Any one) (1)
- 8.2      Connected in delta. ✓ Only three conductors needed for transmission ✓ and not four. There is a huge saving in cost in cables and infrastructure. ✓ (3)
- 8.3      To reduce eddy currents circulating in the core ✓ this causes heat to be generated in the core. ✓ (2)
- 8.4      Given:  $N_P = 800$   
             $N_S = 60$   
             $V_{LP} = 8 \text{ kV}$
- 8.4.1     $V_L = \sqrt{3} \times V_{PH}$
- $$V_{PH} = \frac{V_L}{\sqrt{3}} \quad \checkmark$$
- $$V_{PH} = \frac{8000}{\sqrt{3}} \quad \checkmark$$
- $$= 4618.8V \quad \checkmark \quad (3)$$
- 8.4.2     $\frac{V_{PS}}{V_{PP}} = \frac{N_S}{N_P}$
- $$V_{PS} = \frac{V_{PP} \times N_S}{N_P} \quad \checkmark$$
- $$= \frac{4618.8 \times 60}{800} \quad \checkmark$$
- $$= 346.41V \quad \checkmark \quad (3)$$

8.5 No. ✓  
Power is transferred from the primary to the secondary of the transformer, ✓  
in this transformation process losses occurs in the transformer. ✓ The output  
power is always less than the input power due to losses.

**OR**

The power consumed by the circuit is due to the demand from the load. When  
the power demanded exceeds the rating of the transformer/supply the circuit  
will self protect resulting in load shedding.

(3)  
[15]

**QUESTION 9: LOGIC CONCEPTS AND PLCs**

- 9.1 9.1.1 Push buttons ✓  
Limit switches ✓  
Overload or relay contacts (Any two) (2)
- 9.1.2 Indicator lamps ✓  
Solenoid valves ✓  
Relay or contactor coils (Any two) (2)
- 9.2 9.2.1 Normally open switch ✓ (1)
- 9.2.2 Normally closed switch ✓ (1)
- 9.2.3 Relay, solenoid, coil ✓ (Any one) (1)
- 9.3 9.3.1 AND gate ✓ (1)
- 9.3.2

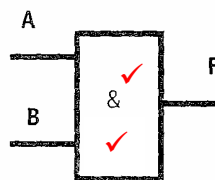

**AND GATE SYMBOL**

One mark for the Input and output labels. One mark for the correct symbol.

(2)

9.3.3

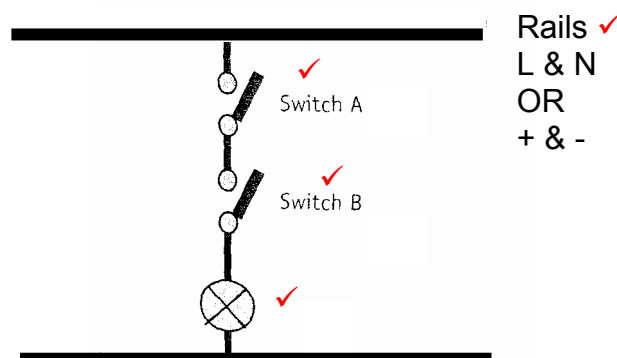

(4)

9.4 9.4.1 Real-time clocks ✓ and timers ✓ denoted by [ T ] ✓ (3)

9.4.2 Adders ✓ and subtractors ✓ denoted by [ C ] ✓ (3)

9.5

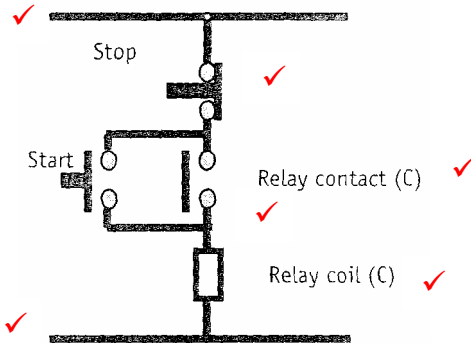

**CONTROL CIRCUIT DIAGRAM OF A STARTER** (6)

9.6 9.6.1 For a control panel with more than ten relays, ✓ a programmable controller is cheaper. ✓ (2)

9.6.2 Installation time is reduced owing to fewer components, ✓ flexible specification changes and simplified wiring. ✓ (2)

9.6.3 Fewer components are subject to wear ✓ and units have built-in diagnostics functions. ✓ (2)

9.7 PLCs are used to automate machinery ✓ in assembly lines and were developed as a substitute ✓ for large relay-based panels. Traffic lights control, motor control, conveyor belts etc. ✓

**OR**

Any other relevant and appropriate answer that relates to automation. (3)  
**[35]**

**QUESTION 10: THREE-PHASE MOTORS AND CONTROL**

- 10.1 Air cooling ✓  
Fan cooling (Any one) (1)
- 10.2 10.2.1  $P = \sqrt{3} \times V_L \times I_L \times \cos \theta$  ✓  
 $= \sqrt{3} \times 380 \times 20 \times 0,8$  ✓  
 $P = 10,53 \text{ kW}$  ✓ (3)
- 10.2.2  $S = \frac{P}{\cos \theta}$  ✓  
 $= \frac{10,53}{0,8}$  ✓  
 $= 13,16 \text{ kVA}$  ✓
- OR**
- $S = \sqrt{3} \times V_L \times I_L$   
 $= \sqrt{3} \times 380 \times 20$   
 $= 13,16 \text{ kVA}$  (3)
- 10.2.3  $I_{ph} = I_L / \sqrt{3}$  ✓  
 $= 20 / \sqrt{3}$  ✓  
 $= 11,55 \text{ A}$  ✓ (3)
- 10.3 Control circuit wiring may be incorrectly wired. ✓  
Motor circuit wiring may be incorrectly wired. ✓  
Overload damage or faulty. ✓ Short circuit in wiring.  
Overloading of the motor if the motor is too small.  
Protective equipment may be faulty. (Any three) (3)
- 10.4 The motor frame must be earthed ✓ to protect the user and protective devices. ✓  
Are the electrical connections fastened and insulated?  
Are the protected devices working properly?  
The correct starter for the motor  
Have the motor test been carried out (Any one)  
For the answer to receive full marks it must contain a statement and a motivation. (2)
- 10.5 Copper losses or  $I^2R$  losses. ✓  
Magnetic or Iron losses. ✓  
Mechanical losses. ✓ (Any three) (3)

- 10.6 An AC supply is connected to the stator winding, which sets up currents in the stator winding. ✓  
Due to the phase difference of the currents a rotating magnetic field is set up in and around the stator. ✓  
The rotating magnetic field sweeps across the rotor conductors, cutting the conductors, inducing an emf across them (Faraday's law) ✓ this in turn sets up currents in the rotor. ✓  
The currents produce a rotating magnetic field in the rotor. ✓  
A force is exerted between the two magnetic fields. ✓ This results in a torque on the rotor and the rotor plates. ✓ (7)
- 10.7 The no-volt coil prevents the circuit from switching on ✓ after a power failure etc. ✓ (2)
- 10.8 Interlocking contact is necessary to prevent both the star and delta contactors ✓ closing at the same time, causing a direct short circuit. ✓ (2)
- 10.9 By changing around/swapping any two of the phases of the supply to the motor ✓ (1)
- [30]**
- TOTAL: 200**