



basic education

Department:
Basic Education
REPUBLIC OF SOUTH AFRICA

**NATIONAL
SENIOR CERTIFICATE**

GRADE 12

ELECTRICAL TECHNOLOGY

FEBRUARY/MARCH 2014

MEMORANDUM

MARKS: 200

This memorandum consists of 14 pages.

INSTRUCTIONS TO MARKERS

1. All questions with multiple answers imply that any relevant, acceptable answer should be considered.
2. Calculations:
 - 2.1 All calculations must show the formula.
 - 2.2 All answers must show the correct unit to be considered.
 - 2.3 Alternative methods must be considered, provided that the same answer is obtained.
 - 2.4 Where an erroneous answer is to be carried over to the next step, the first answer will be deemed incorrect. However, should the incorrect answer be carried over correctly, the marker has to re-calculate the values, using the incorrect answer from the first calculation. If correctly used, the learner should receive the full marks for subsequent calculations.
3. The memorandum is only a guide with model answers. Alternative interpretations must be considered, and marked on merit. However, this principle should be applied consistently throughout the marking session at ALL marking centres.

QUESTION 1: TECHNOLOGY, SOCIETY AND THE ENVIRONMENT

- 1.1 1.1.1 There are many inventions. All answers must be accepted if it is given in the electrical technology context.
EG
Cellular devices✓
Electric driven motor cars
Solar devices
PLC control (1)
- 1.1.2 Answer must be according to answer in 1.1.1
There may be many different answers.

Cellular devices: ✓Cellular devices have given many more people access to information which has allowed for far greater growth of individuals than ever before. ✓ (2)
- 1.2 1.2.1 The generation of power allows for growth in our industries. ✓
Creates employment for people. ✓ (2)
- 1.2.2 With the generation of power there is always pollution ✓as a result of this generation which has a negative impact on the environment✓ (2)
- 1.3 Must have the following skills: financial/accounting✓, marketing, communication, time management.
(Any correct relevant answer) (1)
- 1.4 Entrepreneurs generate their own employment✓ which in return creates employment for others. ✓ (2)
- [10]**

QUESTION 2: TECHNOLOGICAL PROCESS

- 2.1 Primary cells✓
Secondary cells✓
Solar cells✓
Power supply converters
Normal 220 volt AC supply
DC power
AC/DC converters or adaptors.
(Any three) (3)
- 2.2 A design specification gives the parameters as guidance in solving a problem.✓
It is a general description of the type of devices used to solve a problem.✓
It allows you flexibility regarding the type of products used.
It mentions all aspects such as safety, size, materials etc. (Any two) (2)

- 2.3 Any answer in electrical context must be considered.
Example: Control box must be water and fire proof. (2)
- 2.4 To solve a problem. ✓
To prove hypothesis. ✓
To explain phenomenon. ✓
To identify problem stages and make changes. (Any three) (3)
[10]

QUESTION 3: OCCUPATIONAL HEALTH AND SAFETY

- 3.1 Inadequate guards. ✓
Bad ventilation. ✓
Rough or slippery floors. ✓
No personal protection equipment. ✓
Insufficient/Bad lighting.
A disorganised workshop. (Any four) (4)
- 3.2 Safety signs should be provided where necessary to warn of hazards, ✓ to prevent dangerous practices, ✓ and to indicate safe exits and safe practices. ✓ (3)
- 3.3 The workforce is made up with skilled and semi-skilled people that need to be trained and cost the country money ✓. HIV-AIDS results in people getting sick, absence from work ✓ low productivity and loss of human resources. ✓ (3)
[10]

QUESTION 4: THREE-PHASE AC GENERATION

- 4.1 For alternators of similar frame size, three-phase machines produce more power than single – phase machines. ✓
Three-phase alternators can be connected in parallel to obtain a combined power output. ✓
Three-phase power is cheaper to generate than single – phase power of the same power rating.
Three-phase alternators can supply both three and single – phase power. (Any two) (2)
- 4.2 Add power factor correcting capacitors in parallel with the load. ✓
Make use of synchronous motors. ✓
Make use of an AVR in correcting the power factor (alternating automatic voltage regulator). (Any two) (2)
- 4.3 4.3.1 $P_{IN} = \sqrt{3}V_L I_L \cos \theta$ ✓
 $= \sqrt{3} \times 380 \times 25 \times 0.9$ ✓
 $= 14.81 kW$ ✓ (3)

$$\begin{aligned}
 4.3.2 \quad S &= \sqrt{3} V_L I_L \quad \checkmark \\
 &= \sqrt{3} \times 380 \times 25 \quad \checkmark \\
 &= 16.45 \text{ kVA} \quad \checkmark
 \end{aligned}$$

(3)
[10]**QUESTION 5: RLC CIRCUITS**

- 5.1 Watt less voltage divider ✓
Timing circuits ✓
Filter circuits
Oscillating circuits
Radio-tuning circuits
Power factor correction circuits (Any two) (2)
- 5.2 5.2.1 Decrease ✓ (1)
- 5.2.2 If the frequency of the supply increases, the capacitive reactance ✓ and thus the impedance will decrease ✓ causing the current to increase ✓ and thus the brightness of the lamp will increase. ✓ (4)
- 5.3 Capacitive reactance is the opposition offered ✓ by the capacitor to the flow of current in a RC circuit ✓ when the circuit is connected across an alternating-voltage supply and it is measured in ohms. (2)
- 5.4 5.4.1 $X_L = 2\pi fL \quad \checkmark$
 $= 2 \times \pi \times 50 \times 0.22 \quad \checkmark$
 $= 69.12 \Omega \quad \checkmark$ (3)
- 5.4.2 $X_C = \frac{1}{2\pi fC} \quad \checkmark$
 $= \frac{1}{2 \times \pi \times 50 \times (55 \times 10^{-6})} \quad \checkmark$
 $= 57.87 \Omega \quad \checkmark$ (3)
- 5.4.3 $I_L = \frac{V}{X_L} \quad \checkmark$
 $= \frac{220}{69.12} \quad \checkmark$
 $= 3.18 \text{ A} \quad \checkmark$ (3)

$$\begin{aligned}
 I_C &= \frac{V}{X_C} \quad \checkmark \\
 &= \frac{220}{57.87} \quad \checkmark \\
 &= 3.8 \text{ A} \quad \checkmark
 \end{aligned}
 \tag{3}$$

$$\begin{aligned}
 I_R &= \frac{V}{R} \quad \checkmark \\
 &= \frac{220}{47} \quad \checkmark \\
 &= 4.68 \text{ A} \quad \checkmark
 \end{aligned}
 \tag{3}$$

$$\begin{aligned}
 5.4.4 \quad I_S &= \sqrt{I_R^2 + (I_C - I_L)^2} \quad \checkmark \\
 &= \sqrt{4.68^2 + (3.18 - 3.8)^2} \quad \checkmark \\
 &= 4.72 \text{ A} \quad \checkmark
 \end{aligned}
 \tag{3}$$

$$\begin{aligned}
 5.5 \quad V_S &= \sqrt{V_R^2 + (V_L - V_C)^2} \quad \checkmark \\
 &= \sqrt{100^2 + (261 - 65)^2} \quad \checkmark \\
 &= 220 \text{ V} \quad \checkmark
 \end{aligned}
 \tag{3}$$

[30]

QUESTION 6: SWITCHING AND CONTROL CIRCUITS

6.1

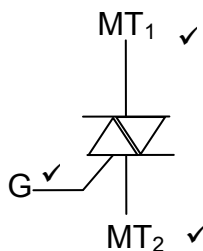

Drawing without labels = 1 mark (3)

6.2 A voltage ✓ of either polarity must be applied across the terminals of the TRIAC and then when a trigger signal is applied to the Gate, ✓ the TRIAC will conduct.

OR

A voltage of either polarity is applied across the terminals of the TRIAC ✓ and increased until it reaches V_{BO} of the TRIAC it will then conduct. ✓ (4)

6.3 A TRIAC conducts in both directions ✓ and an SCR can only conduct in one direction. ✓
OR
The TRIAC gives full wave control in a circuit while a SCR control only half wave of the circuit (2)

6.4 6.4.1 Amps ✓
Volts ✓ (2)

6.4.2 At point 3, the internal resistance of the DIAC decreases rapidly.
The current flow in the DIAC will INCREASE ✓ and the voltage across the DIAC will DECREASE ✓ rapidly. (2)

6.4.3 The voltage supply across ✓ the DIAC must be removed. ✓
OR
The current through the DIAC must be lowered below the holding current of the DIAC it will then switch off. (2)

6.5 6.5.1 R_1 limits the current to protect the diode when R_2 is set at its minimum. ✓ (1)

6.5.2 The control of the brightness of the lamp depends upon the value of R_2 and the value of the capacitor. ✓ The time constant is calculated by $t=5RC$. ✓ Therefore if R_2 is changed the time for the capacitor to charge will also change. ✓ This will change the time it takes the voltage to reach the voltage that triggers the gate of the SCR ✓ and fire the SCR into conduction therefore controlling the brightness of the lamp. ✓ (5)

6.5.3

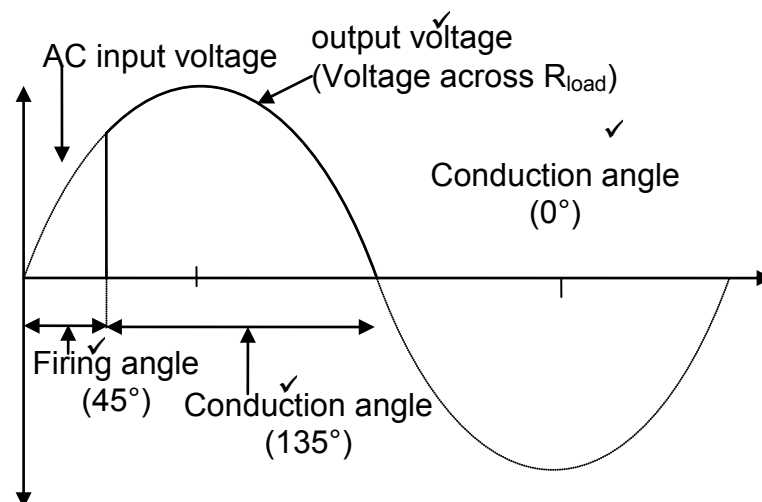

(4)
[25]

QUESTION 7: AMPLIFIERS

- 7.1 Open-loop voltage gain $A_V = \text{infinite}$ ✓
 Input impedance $Z_{IN} = \text{infinite}$ ✓
 Output impedance $Z_{OUT} = \text{zero}$ ✓
 Bandwidth = infinite
 Unconditional stability
 Differential inputs, i.e. two inputs
 Infinite common mode rejection
- (Any three) (3)

- 7.2 7.2.1 Voltage comparator. ✓ (1)

7.2.2

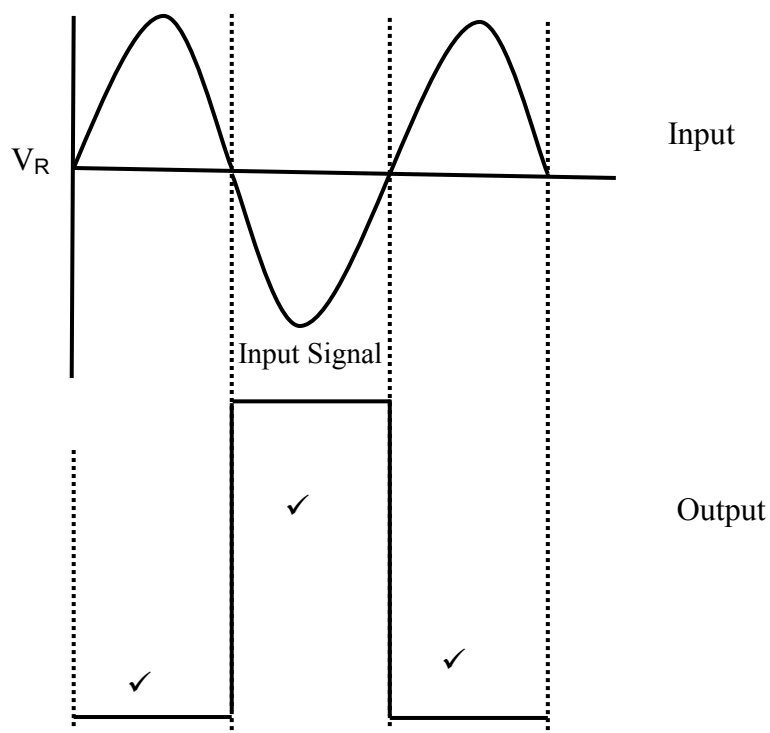

(3)

- 7.3 7.3.1 Positive feedback ✓ (1)

- 7.3.2 1 – Summing point ✓
 2 – Amplifier circuit ✓
 3 – feedback circuit ✓ (3)

- 7.4 Negative feedback allows control of gain, ✓input and output impedance and bandwidth. ✓
OR
 The negative feedback reduces distortion of the output and makes the output more predictable. (2)

- 7.5 Inverting mode ✓
 Non-inverting mode ✓ (2)

- 7.6 Signal amplification ✓
Wave shaping ✓
Process control
Instrumentation (both analogue and digital)
Oscillators
Filters
Analogue to digital conversions
(Any two) (2)

- 7.7 The gain is not infinite ✓
Small input bias currents flow ✓
Limited in their current drive capability at the output
Cannot handle all possible frequencies. Gain reduced when input signal frequency reaches high values
(Any two) (2)

7.8

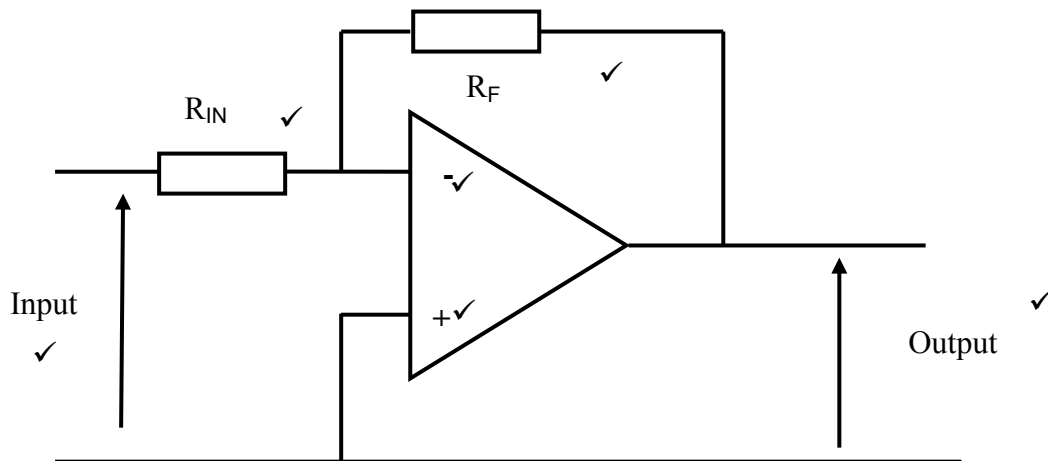

(6)
[25]

QUESTION 8: THREE-PHASE TRANSFORMERS

- 8.1 8.1.1 Primary winding ✓
Secondary winding ✓ (2)
- 8.1.2 Star-Delta ✓
Star-Star
Delta-Star
Delta-Delta (1)
- 8.1.3 The transformer is a step-down transformer. ✓ Therefore the secondary current will be greater than the primary current ✓ which in turn results that the secondary windings must be a thicker gauge. ✓ (3)

8.2 Given:

$$P_{\text{OUT}} = 12 \text{ kW}$$

$$\eta = 100\%$$

$$\cos \theta = 0,8$$

8.2.1

$$\begin{aligned} S &= \frac{P}{\cos \theta} \quad \checkmark \\ &= \frac{12000}{0,8} \quad \checkmark \\ &= 15 \text{ kVA} \quad \checkmark \end{aligned}$$

(3)

8.2.2 Copper losses: \checkmark

Copper losses are the I^2R losses, due to the internal resistance of the copper wires \checkmark that are dissipated in the form of heat. \checkmark

OR

Iron Losses:

The losses incurred due to the hysteresis curve of the type of iron used, resulting in eddy current flow.

Stray Losses:

Losses incurred due to stray inductance that does not flow through the iron core and as a result does not induce current in the secondary coil.

Dielectric losses:

The losses due to damage to the insulation, allowing small leakage currents to flow, thus affecting the operation of the transformer.

(Any one)

(3)

8.2.3

If the load is decreased both the primary and secondary currents would also decrease. \checkmark The primary and secondary voltages remain constant \checkmark therefore if the power decreases the currents must decrease. \checkmark

(3)

[15]

QUESTION 9: LOGIC CONCEPTS AND PLCs

9.1

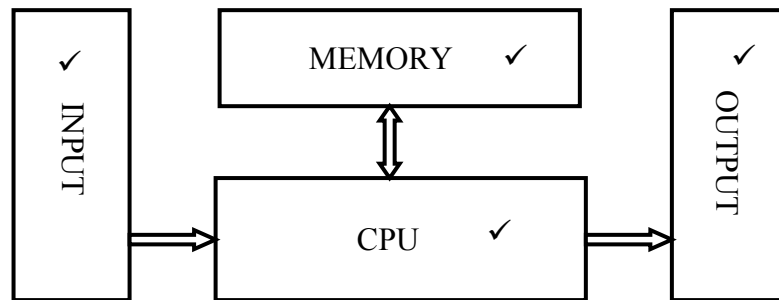

(4)

9.2 PLCs are used to automate machinery in assembly lines ✓ and were developed as substitute for large relay-based panels. ✓

(2)

9.3 It is a graphical language ✓ and method of programming ✓ a PLC. ✓

(3)

9.4 Synchronous counters ✓
Asynchronous counters ✓
Up counters
Down counters

(Any two) (2)

9.5 Inputs ✓
Outputs ✓
Timing devices ✓
Counting devices
Internal relay/flags
Logic operands

(Any three) (3)

9.6 9.6.1

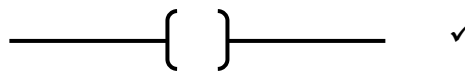

(1)

9.6.2



(1)

9.6.3

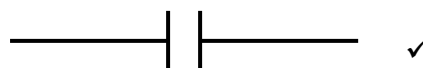

(1)

9.7 9.7.1

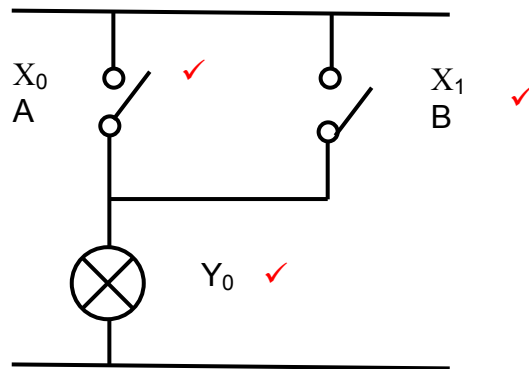

(3)

9.7.2 OR-gate ✓

(1)

9.7.3

A	B	F
0	0	0
0	1	1
1	0	1
1	1	1

✓
✓
✓
✓

(4)

9.7.4

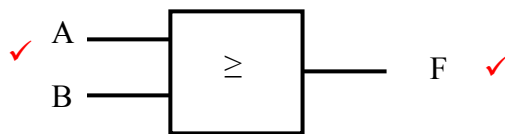

(2)

9.8 9.8.1 Direct on line starter ✓

(1)

9.8.2

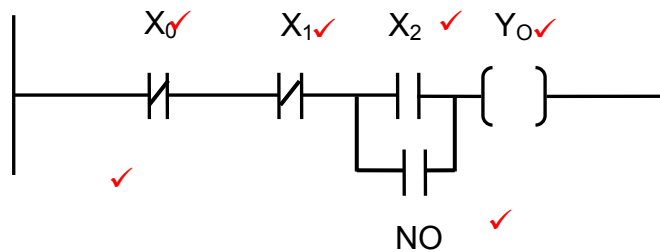

(6)

9.8.3 Motor starter for motors smaller than 4 kW ✓

(1)

[35]

QUESTION 10: THREE-PHASE MOTORS AND CONTROL

- 10.1 Stator. ✓
Rotor. ✓
End plates. ✓
Fan
Terminal box
Bearings
End shields
(Any three) (3)
- 10.2 Copper losses. ✓
Magnetic or iron losses
Mechanical losses
(Any one) (1)
- 10.3 Conveyors ✓
Lifts ✓
Hoists ✓
Elevators
Air conditioning
Extractors
Refrigeration
Boreholes
Pumps
Fans
Distribution plants
Ovens
Furnaces
(Any three) (3)
- 10.4 To immediately interrupt the supply to a machine ✓ to ensure the safety of the operator and the machine. ✓ (2)
- 10.5 It must be located so that the operator has easy access to the switch in the event of an emergency. ✓ (1)
- 10.6 When a short circuit occurs in a winding the resistance of the winding drops ✓ allowing increased current to flow that can cause damage to the motor. ✓ (2)
- 10.7 It is important to do the test because if the reading is not correct, it could indicate a fault ✓ which could lead to an electric shock, ✓ which could lead to risk of injury to the operator. ✓ (3)
- 10.8 The function of the overload unit is to protect ✓ the motor in the event of an overload of current ✓ and set to interrupt the circuit when the current rises above the maximum level for a prolonged period ✓ (3)
- 10.9 The function of a star-delta starter is used to reduce the starting current ✓ of a three-phase motor to prevent tripping at start ✓ of the motor as when a motor starts it draws more than normal full load current. ✓ (3)

10.10 10.10.1 $P = \sqrt{3}V_L I_L \cos \phi$

$$I_L = \frac{P}{\sqrt{3}V_L \cos \phi} \quad \checkmark$$

$$= \frac{5000}{\sqrt{3} \times 380 \times 0.8} \quad \checkmark$$

$$= 9.49 A \quad \checkmark$$

(3)

10.10.2 $I_L = \sqrt{3}I_{PH}$

$$I_{PH} = \frac{I_L}{\sqrt{3}} \quad \checkmark$$

$$= \frac{9.49}{\sqrt{3}} \quad \checkmark$$

$$= 5.48 A \quad \checkmark$$

(3)

10.11 If the power factor of the motor was improved ✓ the motor will draw a lower current to deliver the same power ✓ therefore the apparent power will be reduced. ✓

(3)
[30]

TOTAL: 200