



# basic education

Department:  
Basic Education  
**REPUBLIC OF SOUTH AFRICA**

**NASIONALE  
SENIOR SERTIFIKAAT**

**GRAAD 12**

**INGENIEURSGRAFIKA EN -ONTWERP V2**

**NOVEMBER 2012**

**MEMORANDUM**

**PUNTE: 100**

**Hierdie memorandum bestaan uit 7 bladsye.**

ANTWOORDE		
1	J BURGER	½
2	mm	½
3	2012-07-18	½
4	S GOBA	½
5	CAD/ROT	½
6	382	½
7	4	1
8	0,03	1
9	SLYP	1
10	105°/75°	1
11	44°	1
12	6	1
13	TEENBORING	1
14	VOORAANSIG	1
15	R6	1
16	A. 19 ± 0,05    B. 22    C. Ø30    D. 60    E. 24	5
17	253	3
18	19,05	2
19	187,35 (BO) & 186,55 (ONDER)	4
20		4

TOTAAL: 30

## ANTWOORD 20

● VRYHAND

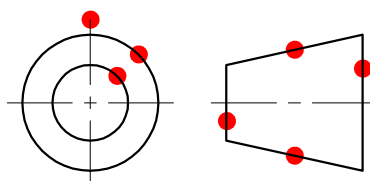

SIMBOOL

VRAESTEL 2 VRAAG 1  
 GRAAD 12  
 NOVEMBER 2012  
 MEMORANDUM

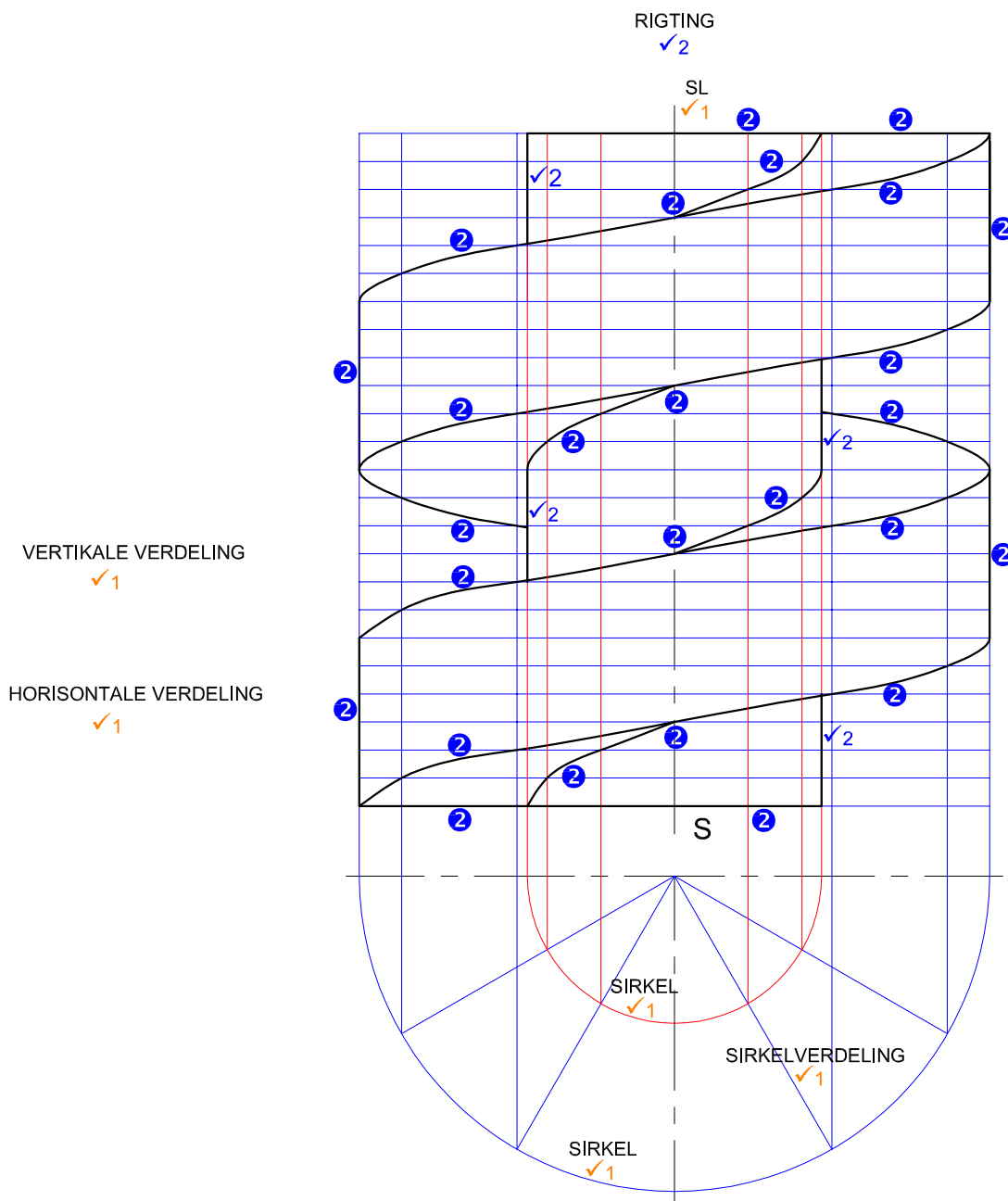

VERTIKALE VERDELING

✓1

HORISONTALE VERDELING

✓1

S

SIRKEL

✓1

SIRKELVERDELING

✓1

SIRKEL

✓1

ASSESSERINGSKRITERIA		
1	SENERLYNE + KONSTR	6
2	HELIKSE + SKAG + RIGTING	18
<b>SUBTOTAAL</b>		<b>24</b>

VRAESTEL 2 VRAAG 2.1  
 GRAAD 12  
 NOVEMBER 2012  
 MEMORANDUM

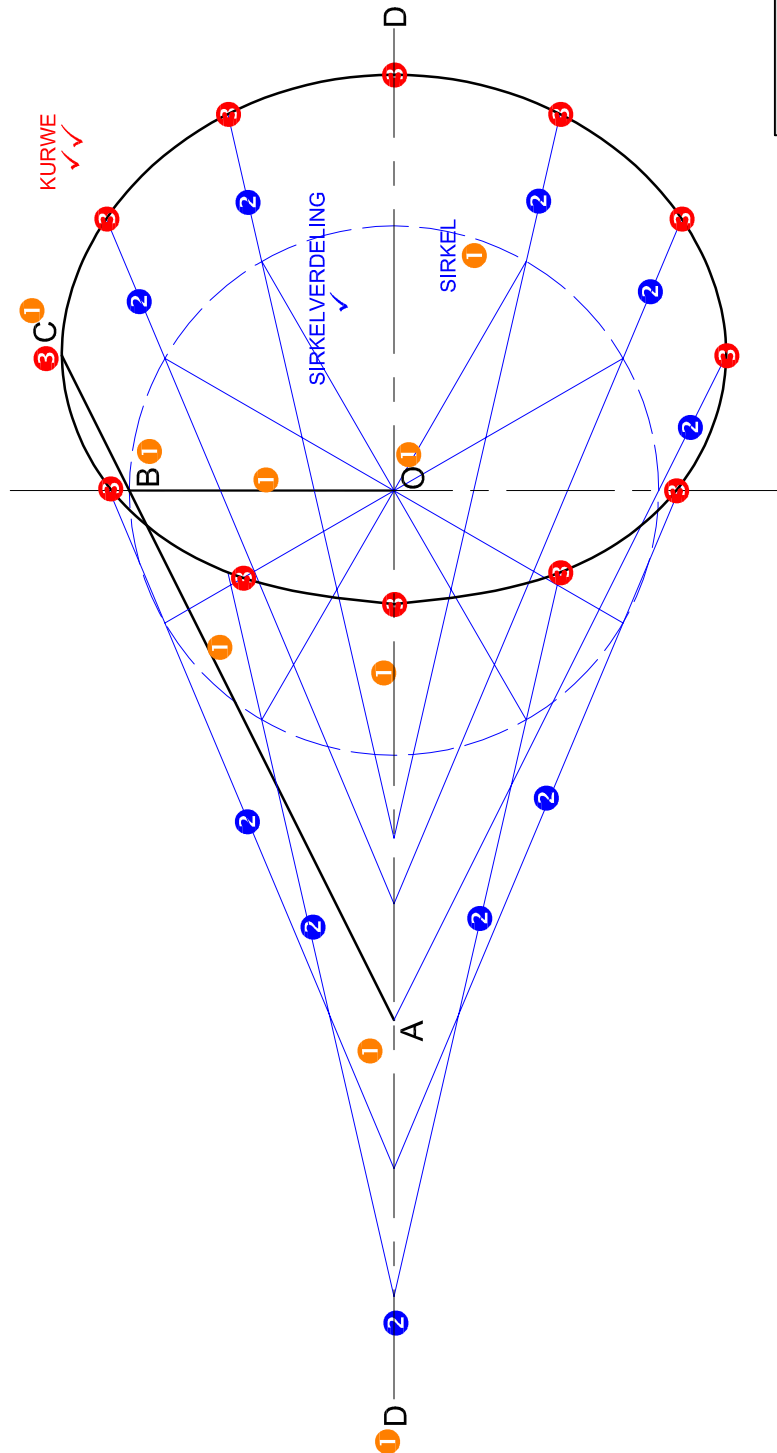

ASSESSERINGSKRITERIA		
1	GEGEE	4
2	KONSTRUKSIE	6
3	LOKUS + KURWE	8
<b>SUBTOTAAL</b>		<b>18</b>
<b>TOTAAL</b>		<b>42</b>

VRAESTEL 2 VRAAG 2.2  
 GRAAD 12  
 NOVEMBER 2012  
 MEMORANDUM

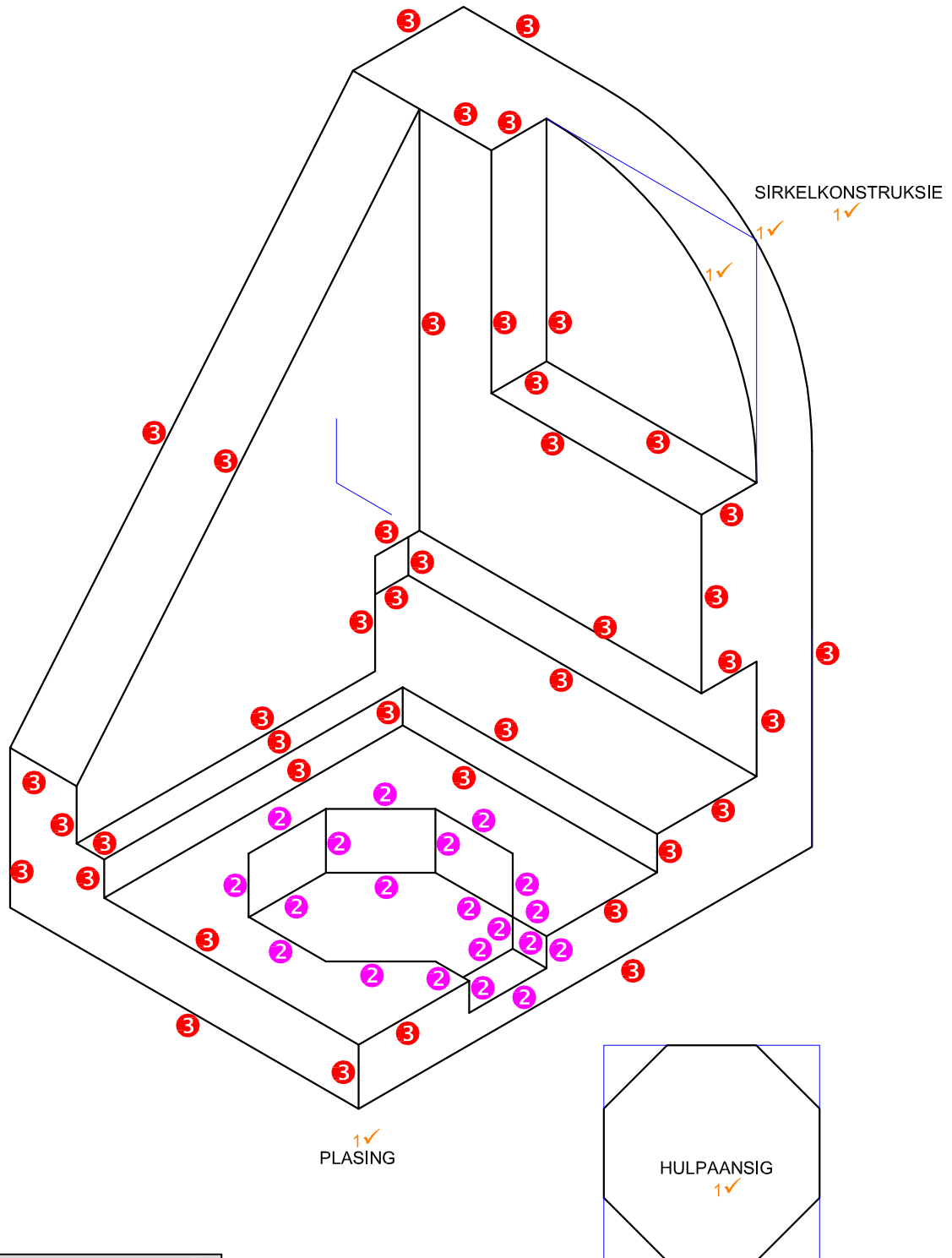

ASSESSERINGSKRITERIA		
1	HULPAANSIGTE + SIRKEL + KONSTRUKSIES + PLASING	5
2	AGTKANTIGE GAT	10
3	ISO'- + NIE-ISO'-LYNE	21
<b>TOTAAL</b>		<b>36</b>

VRAESTEL 2 VRAAG 3  
 GRAAD 12  
 NOVEMBER 2012  
 MEMORANDUM

**DEURSNEE-  
VOORAANSIG**

1	HULSEL	9
2	ONTKOPPELARM	9½
3	SKROEFTAP	3
4	SPASIEERDER	3
5	SPY	2
6	AS	6½
7	HEFBOOM	7
8	WASTER	2
9	M14-MOER	5
H	ARSERING	13
<b>SUBTOTAAL</b>		<b>60</b>

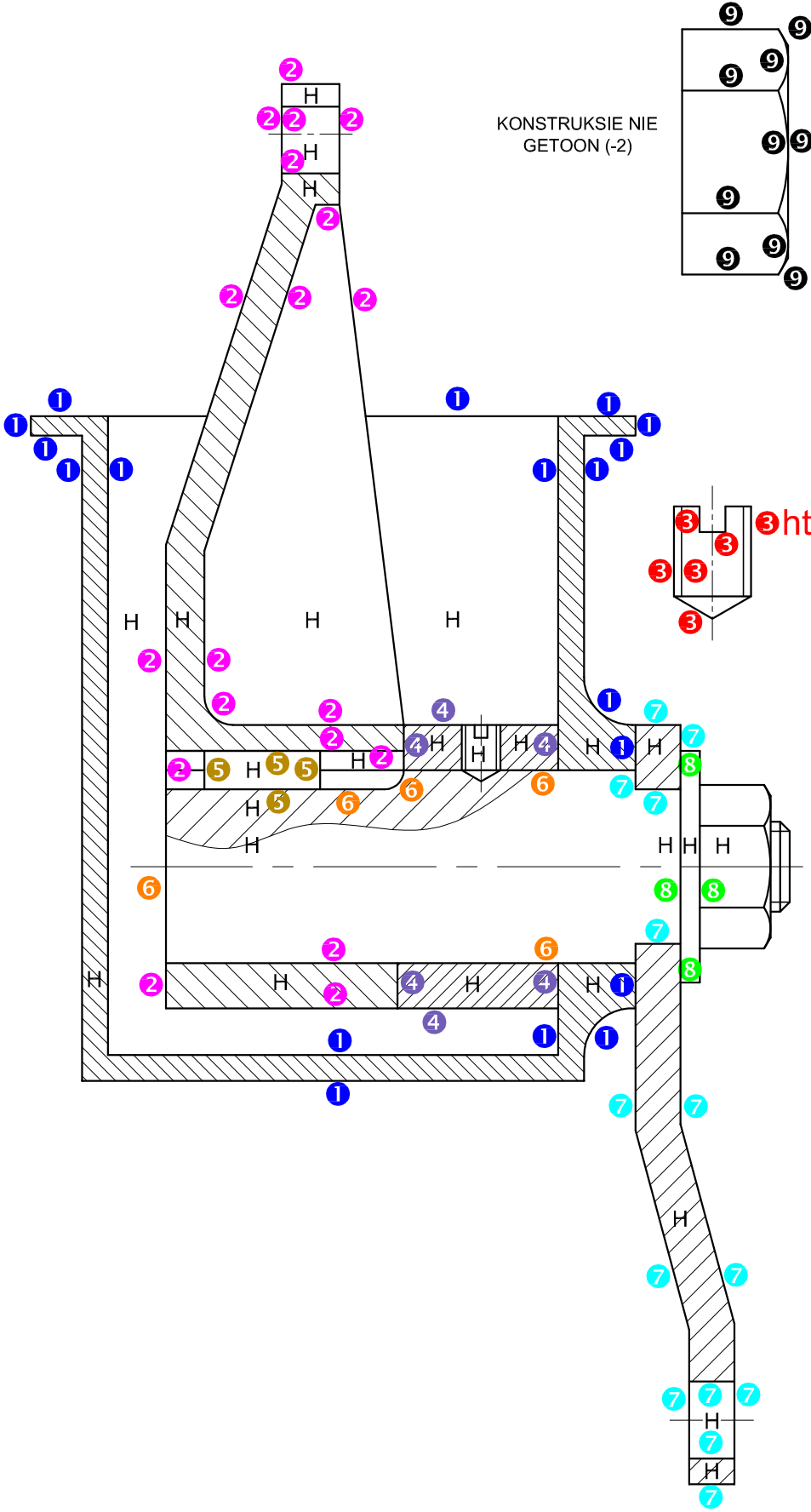

VRAESTEL 2 VRAAG 4  
 GRAAD 12  
 NOVEMBER 2012  
 MEMORANDUM

**REGTERAANSIG**

1	HULSEL	5
2	ONTKOPPELARM	4
3	HEFBOOM	4
4	WASTER + M14-MOER	4
<b>SUBTOTAAL</b>		<b>17</b>

**ALGEMEEN**

1	SENTERLYNE	4
2	SNYVLAK	3
3	SAMESTELLING	8
<b>SUBTOTAAL</b>		<b>15</b>

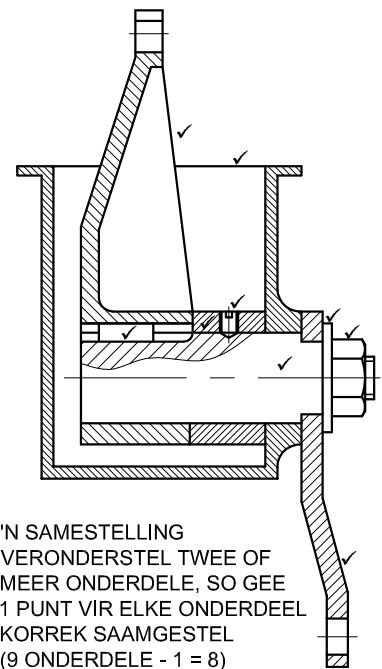
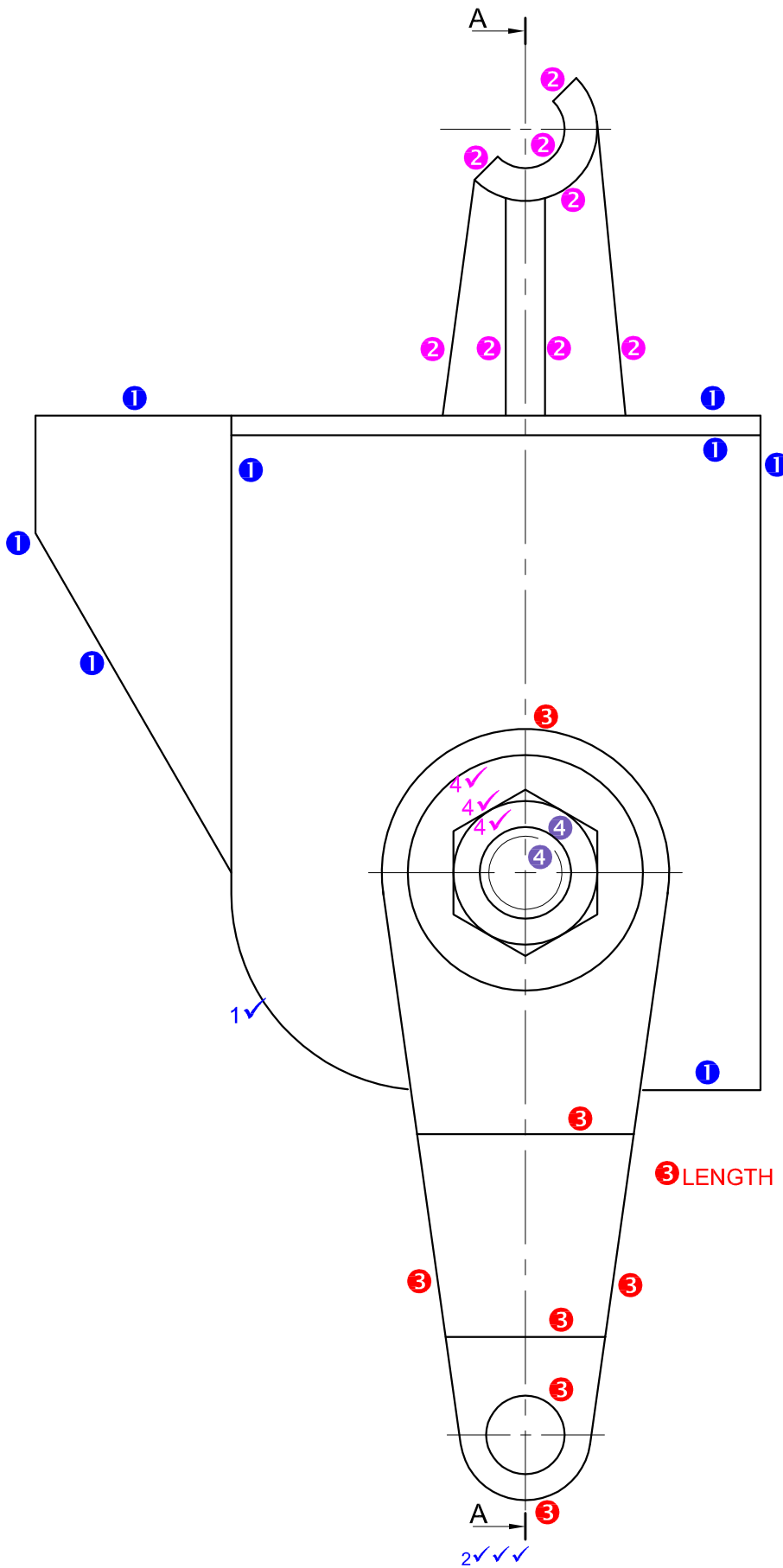

'N SAMESTELLING  
 VERONDERSTEL TWEE OF  
 MEER ONDERDELE, SO GEE  
 1 PUNT VIR ELKE ONDERDEEL  
 KORREK SAAMGESTEL  
 (9 ONDERDELE - 1 = 8)

VRAESTEL 2 VRAAG 4  
 GRAAD 12  
 NOVEMBER 2012  
 MEMORANDUM