



basic education

Department:
Basic Education
REPUBLIC OF SOUTH AFRICA

**NATIONAL
SENIOR CERTIFICATE**

GRADE 12

ENGINEERING GRAPHICS AND DESIGN P2

FEBRUARY/MARCH 2013

MEMORANDUM

MARKS: 100

This memorandum consists of 7 pages.

ANSWERS		
1	2012-07-19	½
2	UFF335.dwg	½
3	INCREASE TOLERANCE	½
4	CAST IRON	½
5	2,5 mm	½
6	6	½
7	MILLING	1
8	ROUGHNESS FACTOR	1
9	FILLET	1
10	Ø50	1
11	KEYWAY	1
12	CURVE OF INTERPENETRATION	1
13	± 0,3	1
14	30	1
15	2	1
16	262	1
17	TOP VIEW	1
18	FULL SECTIONAL FRONT VIEW / MULTI-PLANE SECTIONAL VIEW	1
19	A. Ø76 B. Ø90 C. Ø30 D. 40 E. 10	5
20	Ø25.25	2
21	13.5 (UPPER) & 12.85 (LOWER)	4
22		4

TOTAL: 30

ANSWER 22

● FREEHAND

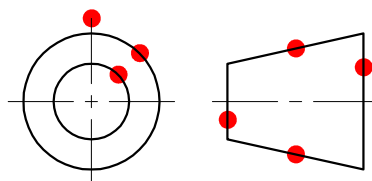

SYMBOL

PAPER 2 QUESTION 1
 GRADE 12
 FEB. - MAR. 2013
 MEMORANDUM

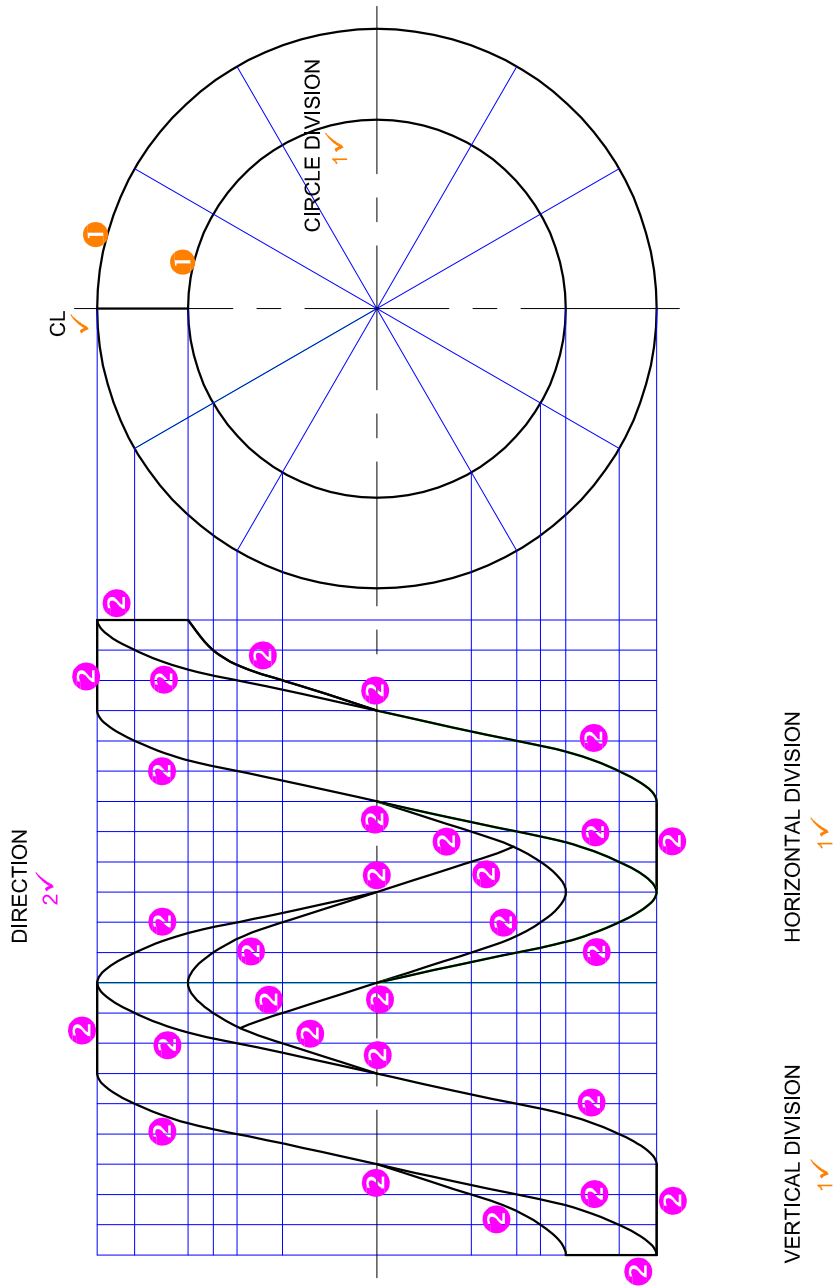

ASSESSMENT CRITERIA	
1	CONSTRUCTION 5
2	POINTS 16
SUBTOTAL 21	

PAPER 2 QUESTION 2.2
 GRADE 12
 FEB. - MAR. 2013
 MEMORANDUM

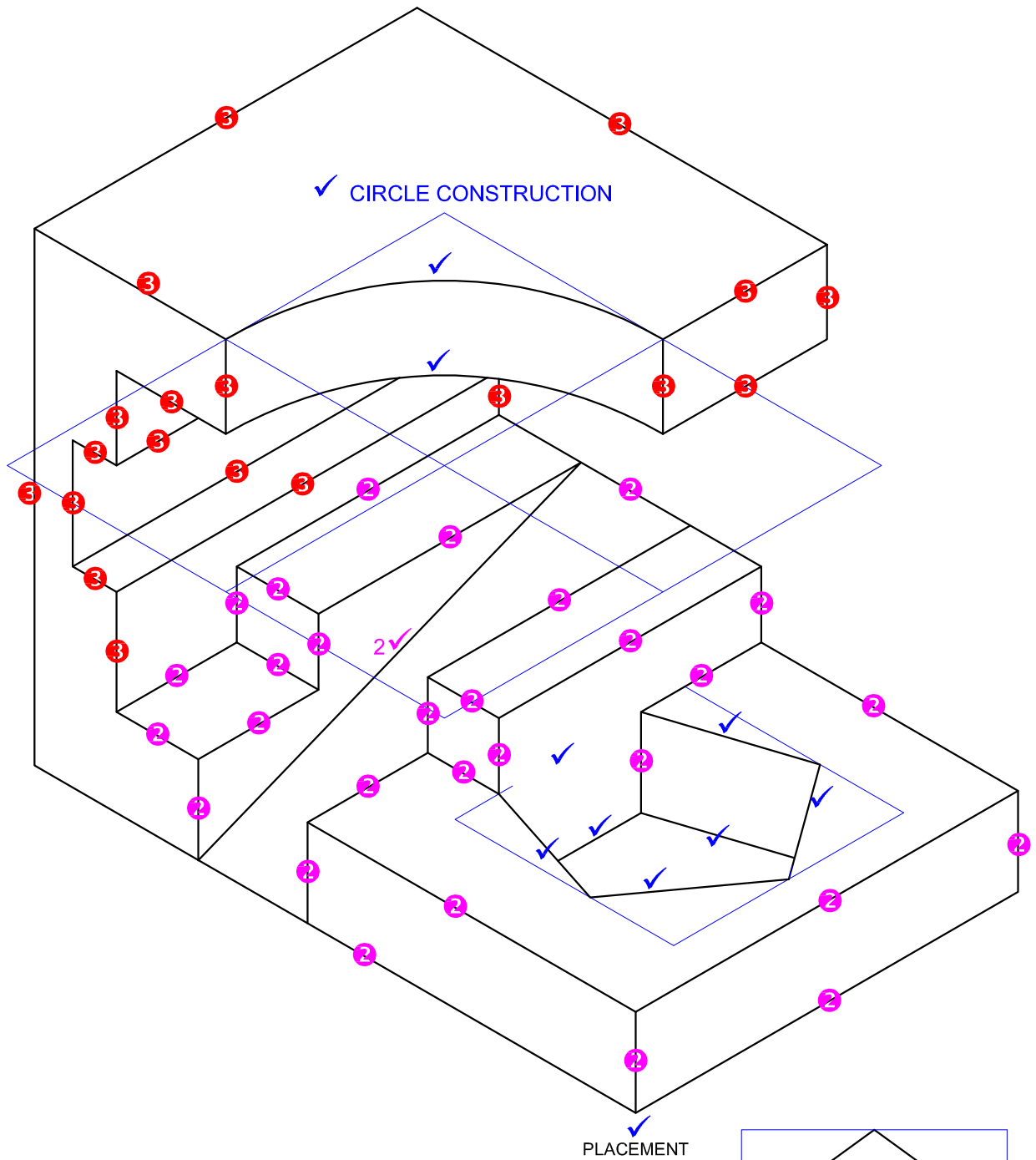

ASSESSMENT CRITERIA		
1	AUX' VIEW + CIRCLE PENTAGON + PLACING	12
2	LOWER PORTION	15½
3	UPPER PORTION	9½
TOTAL		37

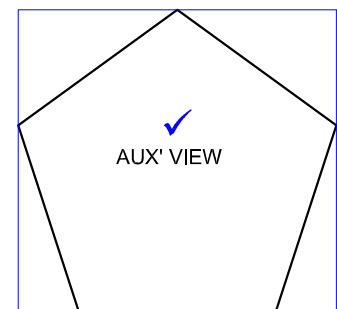

PAPER 2 QUESTION 3
 GRADE 12
 FEB. - MAR. 2013
 MEMORANDUM

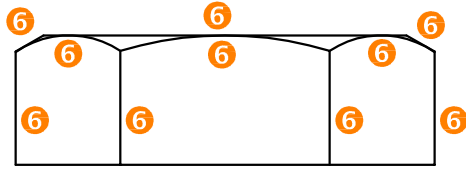

DETAIL OF MARK ALLOCATION FOR M16 NUT

CONSTRUCTION NOT SHOWN (-2)



DETAIL OF MARK ALLOCATION FOR FIBRE SEAL

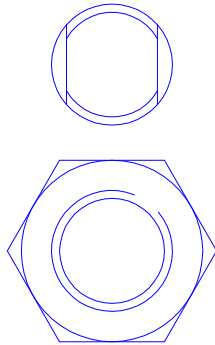

ASSESSMENT CRITERIA		
SECTIONAL FRONT VIEW		
1	VALVE BODY	10
2	SEAL	2
3	SHAFT	6
4	HANDLE	5
5	WASHER	2
6	M16 NUT	5
7	LEFT CUP SEAL	5
8	SPHERE	3
9	RIGHT CUP SEAL	4
10	END CAP	7
H	HATCHING	13
SUBTOTAL		62

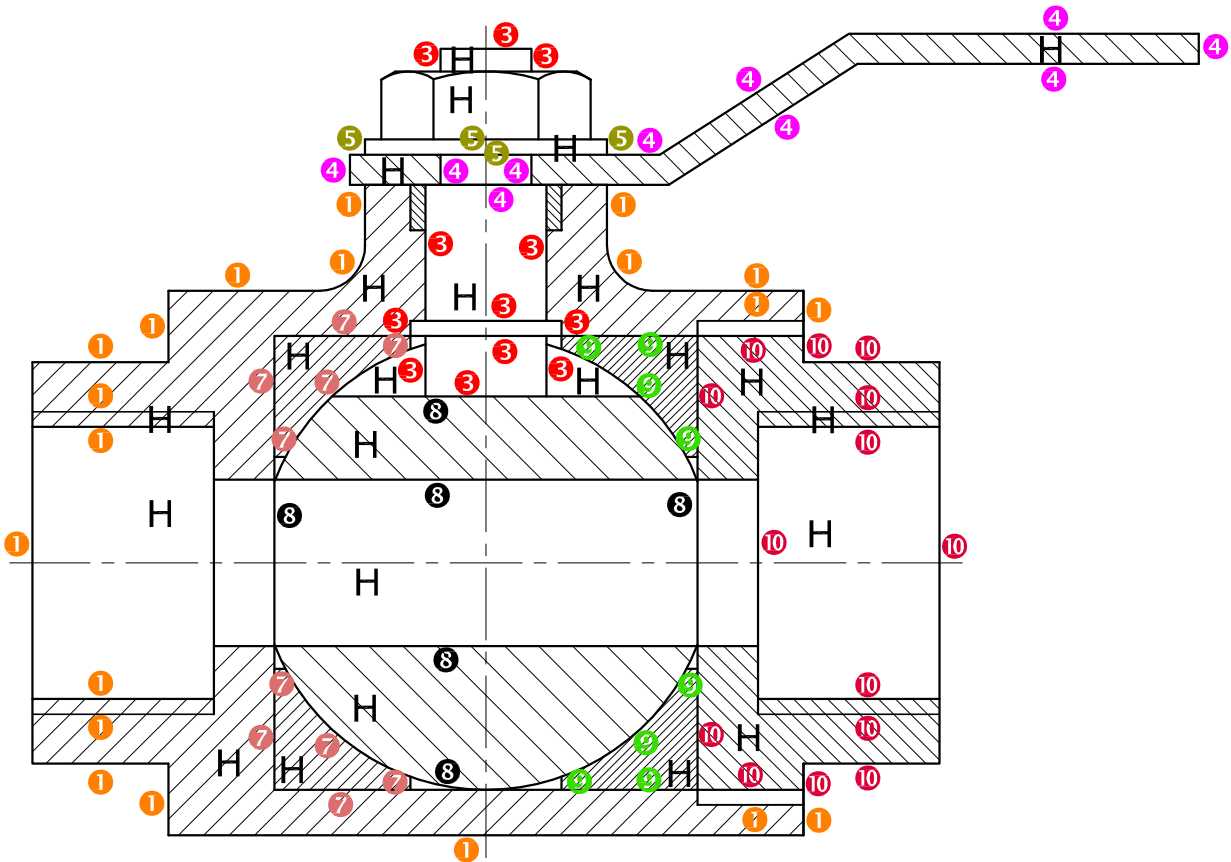

PAPER 2 QUESTION 4
 GRADE 12
 FEB. - MAR. 2013
 MEMORANDUM

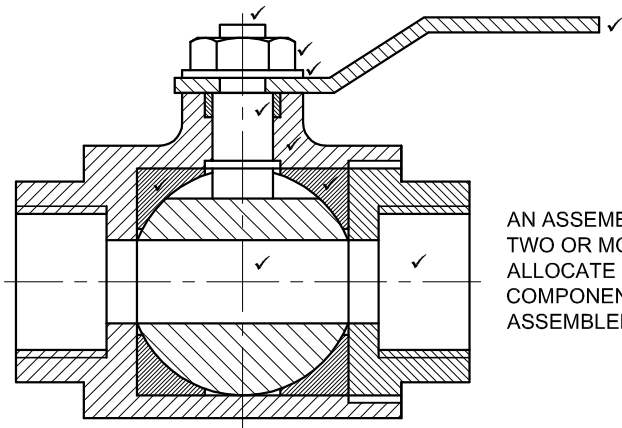

AN ASSEMBLY CONSTITUTES TWO OR MORE PARTS SO ALLOCATE 1 MARK FOR EACH COMPONENT CORRECTLY ASSEMBLED (10 PARTS -1=9)

ASSESSMENT CRITERIA		
LEFT VIEW		
1	HANDLE	2½
2	M16 NUT	4
3	SHAFT	3
4	WASHER	1½
5	VALVE BODY	9
SUBTOTAL		20
GENERAL		
1	CENTRE LINES	2
2	ASSEMBLY	9
SUBTOTAL		11

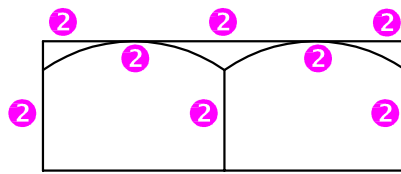

DETAIL OF MARK ALLOCATION FOR M16 NUT

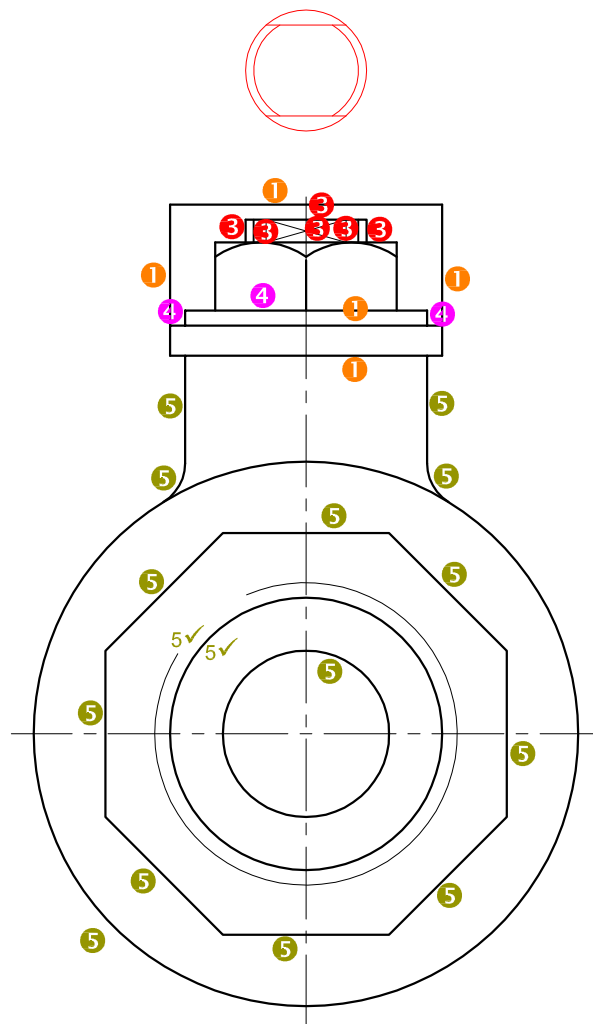

PAPER 2 QUESTION 4
 GRADE 12
 FEB. - MAR. 2013
 MEMORANDUM