



basic education

Department:
Basic Education
REPUBLIC OF SOUTH AFRICA

NASIONALE SENIOR SERTIFIKAAT

GRAAD 12

INGENIEURSGRAFIKA EN -ONTWERP V1

FEBRUARIE/MAART 2011

MEMORANDUM

PUNTE: 100

Hierdie memorandum bestaan uit 5 bladsye.



ANTWOORDE		
1	DIE BUIEGEBOU IS BUIE DIE BOULYN OF DIE DAK VAN DIE BUIEGEBOU IS OOR DIE GRENSLYN.	2
2	79	1
3	1	1
4	SKAAL 1 : 200	1
5	12-04-2010	1
6	KAYSERSSTRAND	1
7	MARLINRYLAAN	1
8	2	1
9	14	1
10	INSPEKSIEOOG	1
11	MANGAT	1
12	BOULYN	1
13	MUNISIPALE RIOOLLYN	1
14	KONTOERLYN	1
15	DAKOORHANG	1
16	GRENSLYN	1
17	EILAND IN DIE PAD	1
18	0.5 m	1
19	SUID	1
20	$37.806 + 24.200 + 10.615 + 30.300 + 31.706 \text{ ①} = 134.627 \checkmark \text{m} \checkmark$	$2\frac{1}{2}$
21	$37.806 \times 31.706 = 1198.67704 \text{ ①}$ $37.806 - 30.3 = 7.506 \text{ ①}$ $7.506 \times 7.506 = 56.340036 \text{ ①}$ $56.340036 / 2 = 28.170018 \text{ ①}$ $1198.67704 - 28.170018 \text{ ①} = 1170.5 \checkmark \text{m}^2 \checkmark$	$4\frac{1}{2}$

TOTAAL: 27

VRAESTEL 1 VRAAG 1
 GRAAD 12
 FEBRUARIE/MAART 2011
 MEMORANDUM

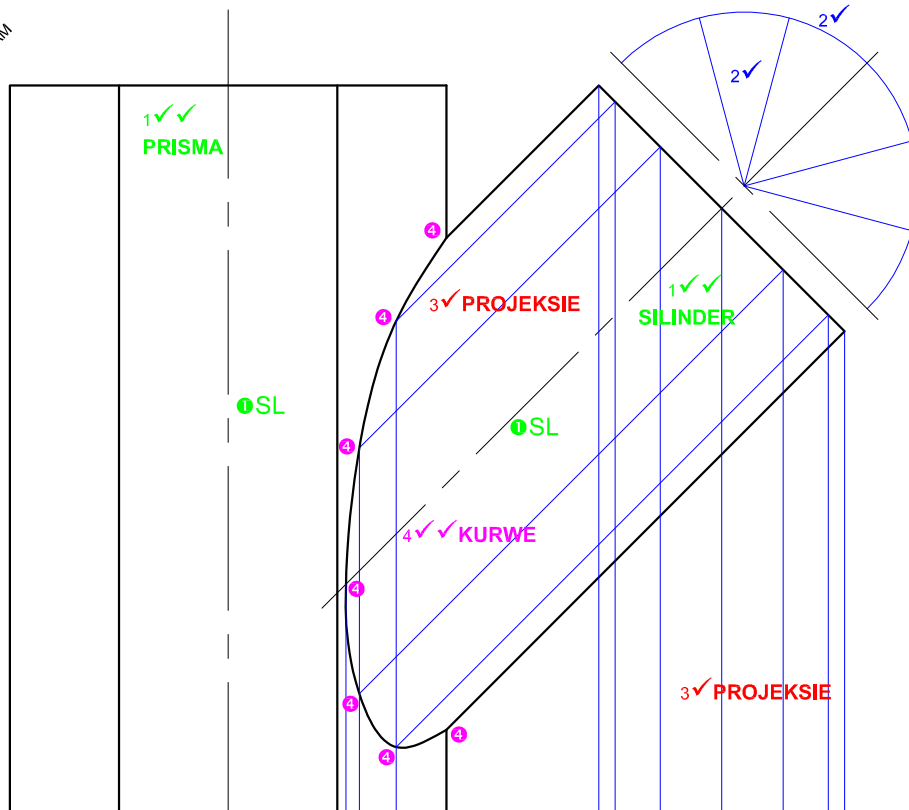

ASSESSERINGSKRITERIA	
1. GEGEE + SENTERLYNE	8
2. HULP-SIRKELS	4
3. PROJEKSIE	4
4. DEURDRINGING	5½
5. BOAANSIG VAN SILINDER	7
6. ONTWIKKELING	11½
TOTAAL	40

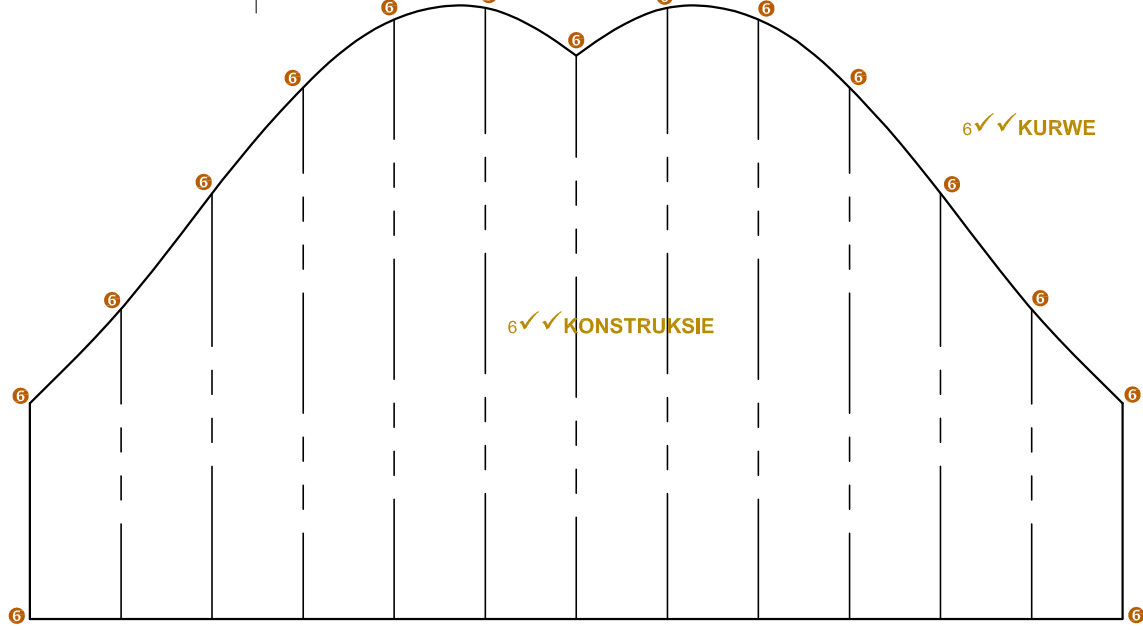
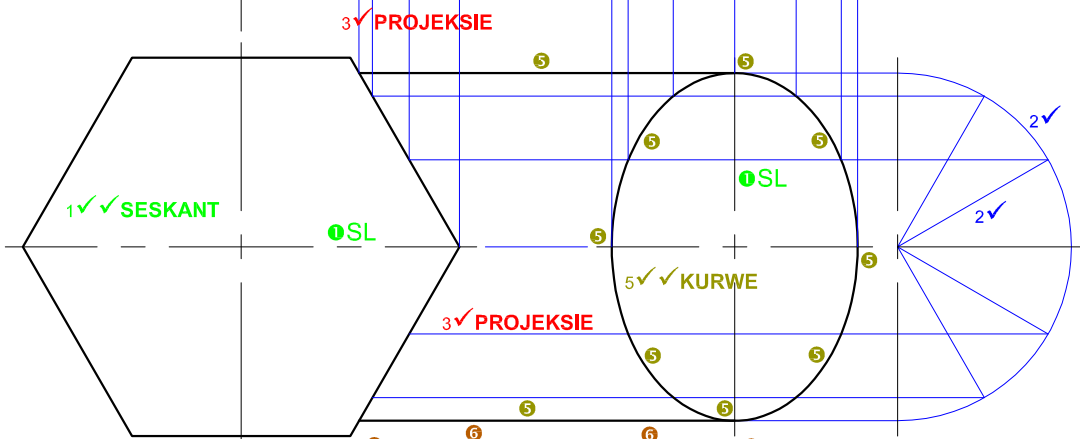

VRAESTEL 1 VRAAG 2
 GRAAD 12
 FEBRUARIE/MAART 2011
 MEMORANDUM

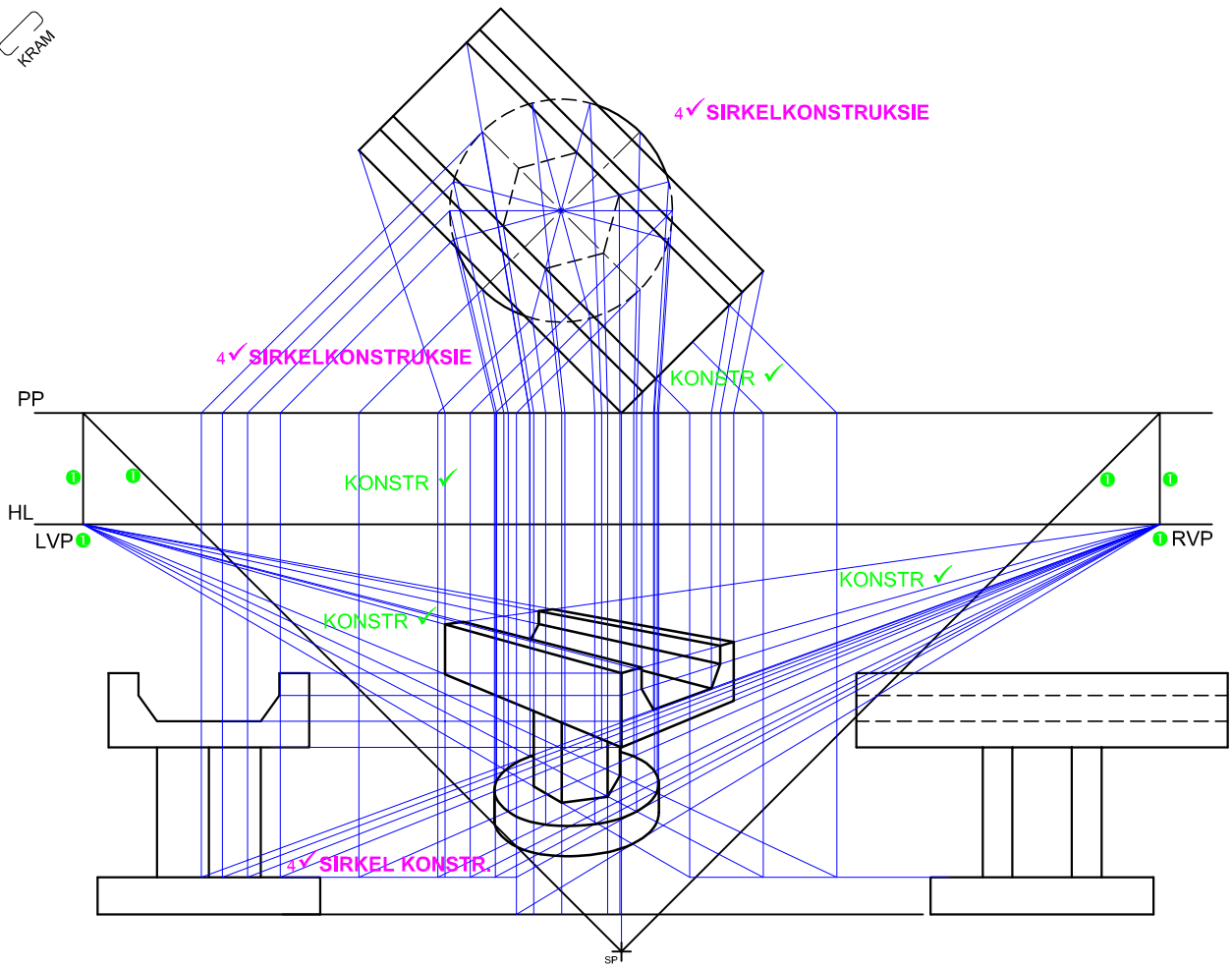

HL _____

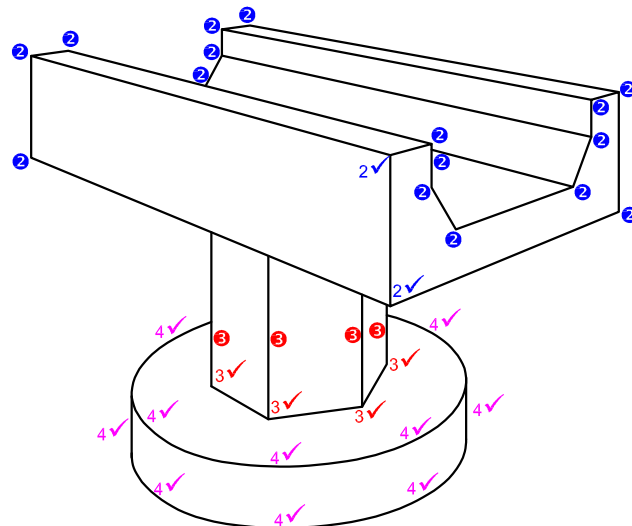

GL _____



ASSESSERINGSKRITERIA	
1. KONSTRUKSIE + VP'e	7
2. PAD	10
3. SESKANTIGE PILAAR	6
4. RONDE BASIS	13
TOTAAL	36

VRAESTEL 1 VRAAG 3
 GRAAD 12
 FEBRUARIE/MAART 2011
 MEMORANDUM

KRAM

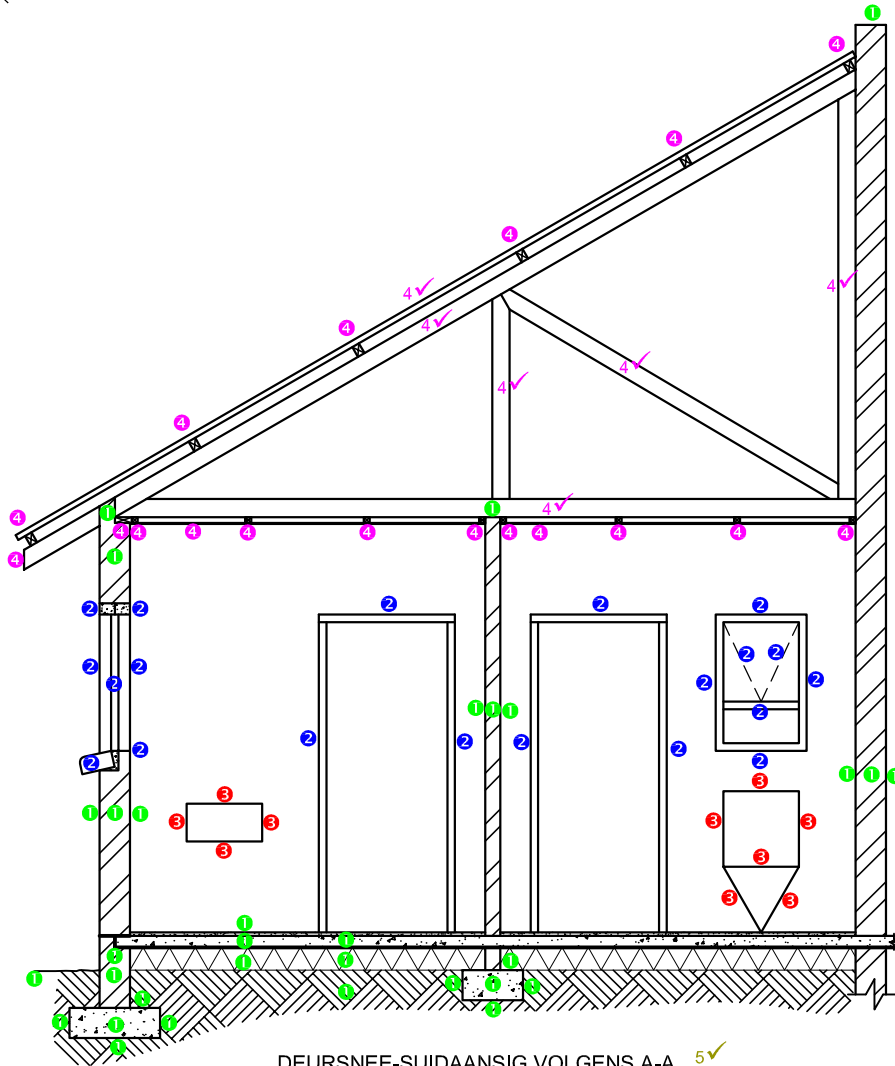

DEURSNEE-SUIDAANSIG VOLGENS A-A 5✓

DEURSNEE-SUIDAANSIG	
1. MURE + ARSERING	16
2. VENSTERS + DEURE	10
3. TOEBEHORE	5
4. DAK + PLAFON	15
5. BYSKRIFTE	1
SUBTOTAAL	47

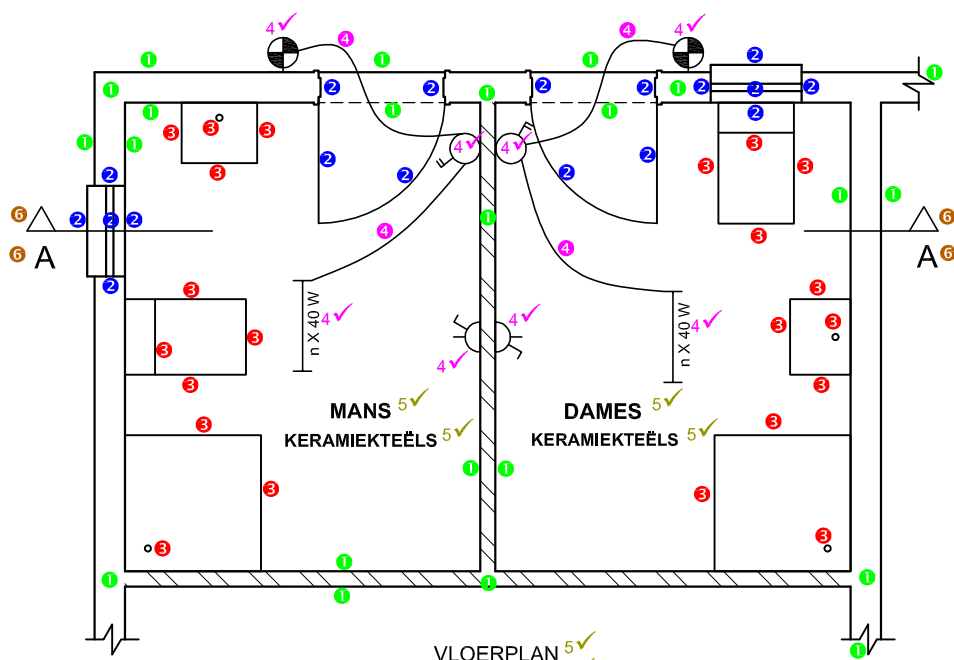

VLOERPLAN 5✓
SKAAL 1 : 50 5✓

VLOERPLAN	
1. MURE + ARSERING	12
2. VENSTERS + DEURE	9
3. TOEBEHORE	11
4. ELEKTRIES	10
5. BYSKRIFTE	6
6. SNYVLAK A-A	2
SUBTOTAAL	50
TOTAAL	97

VRAESTEL 1 VRAAG 4
GRAAD 12
FEBRUARIE/MAART 2011
MEMORANDUM